

Access Arrangement
for
Regasification Terminal Pengerang

(APPROVED BY SURUHANJAYA TENAGA ON 20th OF DECEMBER 2018)

APPENDIX 1 ACCESS ARRANGEMENT

<u>TITLE</u>	<u>PAGE NO.</u>
1.0	DEFINITIONS AND INTERPRETATIONS 3
2.0	ACCESS TO SERVICES 26
3.0	CAPACITY ALLOCATION MECHANISM 27
4.0	SERVICES 28
5.0	FEES 31
6.0	LNG VESSELS 33
7.0	NOMINATIONS AND SCHEDULING 36
8.0	LNG VESSELS' ARRIVAL AND DEPARTURE 50
9.0	RECEIVING FACILITY 61
10.0	MEASUREMENT, ALLOCATION AND RECORDS 63
11.0	MAINTENANCE 67
12.0	SPECIFICATION 69
13.0	COMMINGLING, TITLE AND RISK 75
14.0	UNDERTAKINGS 76
15.0	LIABILITIES AND INDEMNITIES 76
16.0	INTERNAL GAS CONSUMPTION 78
17.0	INVOICING, PAYMENTS, TAXES AND DUTIES 79
18.0	CREDIT SUPPORT 82
19.0	SUSPENSION 82
20.0	TERMINATION 83
21.0	CHANGE OF LAW 84
22.0	FORCE MAJEURE 85
23.0	INSURANCE 87
24.0	CONFIDENTIALITY 88
25.0	NOTICES 89
26.0	ASSIGNMENT AND SERVICES TRANSFER 89
27.0	USE IT OR LOSE IT 92
28.0	INTER-CAPACITY USER AGREEMENT 93
29.0	REVISIONS TO THE ACCESS ARRANGEMENT 93
30.0	FURTHER ASSURANCE 94
31.0	ENTIRE AGREEMENT 95
32.0	SURVIVAL OF RIGHTS, DUTIES AND OBLIGATIONS 95
33.0	ANNOUNCEMENTS 95
34.0	SEVERANCE 95
35.0	WAIVER 95
36.0	MITIGATION 95
37.0	EXPERT DETERMINATION 95
38.0	DISPUTE RESOLUTION 96
39.0	GOVERNING LAW 99
40.0	SOVEREIGN IMMUNITY 99
41.0	CODE OF CONDUCT AND BUSINESS ETHICS 99
42.0	DISCLAIMER OF AGENCY 101
43.0	REPRESENTATIONS AND WARRANTIES 102
44.0	CHANGE OF CIRCUMSTANCES 104
	SCHEDULE 1 LNG VESSELS SPECIFICATION, VETTING AND ACCEPTANCE PROCEDURES 105

SCHEDULE 2 MEASUREMENT RULES	108
SCHEDULE 3 LNG SPECIFICATION	113
SCHEDULE 4 SEND OUT GAS SPECIFICATIONS	114
SCHEDULE 5 LNG TERMINAL FACILITY INFORMATION	115
SCHEDULE 6 ALLOCATION RULES	122
SCHEDULE 7 PDWT PORT LIMIT	124
SCHEDULE 8 DAILY SEND OUT GAS NOMINATION PROCEDURE	126
SCHEDULE 9 FORM OF ACCESS REQUEST.....	127
SCHEDULE 10 CAPACITY USER CREDIT REQUIREMENTS	128
SCHEDULE 11 FORM OF NOVATION AGREEMENT FOR ENTIRE SERVICE TRANSFER	132
SCHEDULE 12 FORM OF INTER-CAPACITY USER AGREEMENT.....	138
SCHEDULE 13 FORM OF PARTIAL SERVICE TRANSFER APPROVAL	139
SCHEDULE 14 CALORIFIC AND VOLUMETRIC CONVERSION FORMULA	141

1.0 DEFINITIONS AND INTERPRETATIONS

1.1 Definitions

The following terms used in a TERMINAL USE AGREEMENT shall have the respective meanings hereby assigned to them

AA CHANGE REQUEST	shall have the meaning set forth in AA 29.1;
ACCESS ARRANGEMENT or AA	means this access arrangement (including the schedules hereto) adopted by OPERATOR in accordance with the TPA CODE and APPLICABLE LAWS;
ACCESS REQUEST	means a written proposal to enter into a TERMINAL USE AGREEMENT, which is submitted in accordance with AA 2.0 and AA 3.3 and is substantially in the form provided at Schedule 9;
ACCESS REQUIREMENTS	shall have the meaning set forth in AA 2.1;
ADDITIONAL PARTY	shall have the meaning set forth in AA 38.7(d)(i);
ADVERSE WEATHER CONDITIONS	means weather and/or sea conditions actually experienced that are sufficiently severe to (a) prevent an LNG VESSEL from proceeding to berth, unloading LNG, remaining berthed or departing from the berth in accordance with weather standards prescribed in published regulations in effect at the JOHOR PORT AUTHORITY and by the order of MMS, or (b) cause a reasonable determination by the MASTER of such LNG VESSEL that it would be unsafe for such LNG VESSEL to proceed to berth, unload LNG, remain at, or depart the berth;
AFFECTED PARTY	shall have the meaning set forth in AA 22.1
AFFILIATE	means a person (other than a PARTY) who directly or indirectly controls, is controlled by, or is under common control with, a PARTY to a TERMINAL USE AGREEMENT, and for such purposes the terms "control", "controlled by" and other derivatives shall mean the direct or indirect ownership of fifty per cent (50%) or more of the voting rights in a person;
AIAC	shall have the meaning set forth in AA 38.2;
ALL FAST	means, in respect of an LNG VESSEL, the time when such LNG VESSEL is safely moored with all mooring lines attached to the berth at the LNG jetty to the satisfaction of OPERATOR and the MASTER of such LNG VESSEL;

ALLOWED RELOADING TIME	means, in respect of an LNG VESSEL, the period specified in AA 8.4(a)(ii) for an LNG VESSEL of the same maximum cargo capacity (as that period may be extended pursuant to AA 8.4(f));
ALLOWED UNLOADING TIME	means, in respect of an LNG VESSEL, the period specified in AA 8.4(a)(i) for an LNG VESSEL of the same maximum cargo capacity (as that period may be extended pursuant to AA 8.4(f));
ANNUAL CONTRACT QUANTITY or ACQ	<p>means, for a particular CONTRACT YEAR, but subject to adjustment in accordance with the terms of the TERMINAL USE AGREEMENT (including for the avoidance of doubt any adjustments as a result of a PARTIAL SERVICE TRANSFER or interruption in the availability of a CAPACITY USER'S daily firm contractual entitlement), the quantity (expressed in m³) of NATURAL GAS and/or LNG (reduced on a pro rata basis in respect of any CONTRACT YEAR of less than 365 days) which a CAPACITY USER is entitled under its TERMINAL USE AGREEMENT to have:</p> <ul style="list-style-type: none"> (a) regasified from LNG at the RECEIVING FACILITY and delivered to the NATURAL GAS DELIVERY POINT; and/or (b) reloaded from the RECEIVING FACILITY onto an LNG VESSEL at the LNG RELOAD DELIVERY POINT, <p>in a CONTRACT YEAR as stated in respect of the CAPACITY USER in the TERMINAL USE AGREEMENT;</p>
ANNUAL MAINTENANCE PROGRAMME	means the programme setting out the timing and scheduling of the shutdown of the RECEIVING FACILITY for any CONTRACT YEAR, which shall include any MANDATORY REGULATORY SHUTDOWN, and which shall be as further described in AA 11.1;
ANNUAL NOMINATION SCHEDULE	shall have the meaning set forth in AA 7.1;
ANNUAL OPERATION SCHEDULE	means the schedule developed and determined in accordance with AA 7.6 as the same may be revised pursuant to this ACCESS ARRANGEMENT.

ANTICIPATED IGC	means, for each CONTRACT YEAR, the volume of NATURAL GAS forecast by OPERATOR to be consumed, lost and/or unaccounted for in the LNG TERMINAL FACILITY in such CONTRACT YEAR, such forecast to be updated every three (3) CONTRACT YEARS by OPERATOR based on the LNG TERMINAL FACILITY'S performance;
APPLICABLE LAWS	means the applicable laws of Malaysia;
APPLICANT	means any CAPACITY USER or any PROSPECTIVE CAPACITY USER which applies to OPERATOR to receive SERVICES from OPERATOR;
AUTHORISATIONS	means all consents, authorisations, licences, waivers, permits, approvals and other similar documents from or by a GOVERNMENTAL AUTHORITY;
AUXILIARY SERVICES	means services (excluding REGASIFICATION SERVICES) provided or to be provided at the RECEIVING FACILITY OPERATOR including INTERRUPTIBLE REGASIFICATION SERVICES, STORAGE SERVICES and RELOAD SERVICES ;
AVAILABLE CAPACITY	shall have the meaning set forth in AA 3.1(a);
BERTHING SLOT	means the SCHEDULED DATE OF ARRIVAL and the associated ALLOWED UNLOADING TIME or ALLOWED RELOADING TIME allotted or to be allotted to CAPACITY USER in the issued ANNUAL OPERATION SCHEDULE and/or THREE MONTH SCHEDULE as being the time during which an LNG VESSEL is scheduled to arrive at the PILOT BOARDING STATION, transit to the RECEIVING FACILITY, berth and unload or reload;
BOIL OFF GAS	means vaporised LNG that results from LNG reaching its boiling point;
BORROWING AND LENDING SCHEDULE	shall have the meaning set forth in the INTER-CAPACITY USER AGREEMENT;
BRITISH THERMAL UNIT or BTU	means the amount of heat required to raise the temperature of one (1) avoirdupois pound of pure water from fifty nine degrees Fahrenheit (59°F) to sixty degrees Fahrenheit (60°F) at an absolute pressure of fourteen and six hundred ninety-six thousand (14.696) psia;
CAPACITY ALLOCATION GUIDELINES	means the guidelines set forth in Schedule 15;

CAPACITY USER	means, in relation to a TERMINAL USE AGREEMENT, a person who has purchased the right to SERVICES under the terms of that TERMINAL USE AGREEMENT;
CAPACITY USER EVENT OF DEFAULT	shall have the meaning set forth in AA 20.2;
CARGO or CARGOES	means LNG carried by an LNG VESSEL in relation to which OPERATOR will render the SERVICES to CAPACITY USER under the TERMINAL USE AGREEMENT;
CELSIUS	means the metric scale temperature where zero point zero one degree Celsius (0.01°C) is the triple point of water and a difference in temperature of one degree Celsius (1°C) corresponds to one over two-hundred and seventy-three and sixteen hundredths (1/273.16) of the difference in temperature between the triple point and absolute zero;
COMMON DISPUTES	shall have the meaning set forth in AA 38.7(a);
COMMON TRIBUNAL	shall have the meaning set forth in AA 38.7(a);
COMMUNICATION PROTOCOL	means, collectively, the various operations communication documents or manuals issued by OPERATOR as the same shall be amended and updated from time to time for the interface between OPERATOR and CAPACITY USERS for the implementation of the TERMINAL USE AGREEMENT;
CONFIDENTIAL INFORMATION	means the terms of the TERMINAL USE AGREEMENT and all communications, information and other material disclosed by a PARTY to another PARTY (whether orally, in writing or in some other permanent form) in connection with the TERMINAL USE AGREEMENT which is not: <ul style="list-style-type: none"> (a) already known to the recipient; or (b) already in the public domain (other than as a result of a breach of AA 24.0);
CONSOLIDATION ORDER	shall have the meaning set forth in AA 38.7(b);
CONTRACT MONTH	means each calendar month of a CONTRACT YEAR, provided that;

(a) the first (1st) CONTRACT MONTH means the period beginning on the SERVICE COMMENCEMENT DATE and ending on the last day of the calendar month during which the SERVICE COMMENCEMENT DATE occurs; and

(b) the last CONTRACT MONTH means the period beginning on the first (1st) day of the calendar month in which the last day of the TERM falls and ending on the last day of the TERM;

CONTRACT YEAR

means each annual period starting at 0600 hours on 1st January and ending at 0600 hours on the immediately following 1st January during the TERM, provided that:

(a) the first CONTRACT YEAR shall commence at 0600 hours on the SERVICE COMMENCEMENT DATE and end at 0600 hours on 1st January immediately following the SERVICE COMMENCEMENT DATE; and

(b) the last CONTRACT YEAR shall commence at 0600 hours on 1st January immediately preceding the last day of the TERM and end at the end of the TERM;

CUBIC METRE or m³

means a volume equal to the volume of a cube, each edge of which is one metre;

CURTAILMENT ORDER

shall have the meaning set forth in AA 4.2;

DAILY SEND OUT GAS NOMINATION

shall have the meaning set forth in AA 7.11(c);

DEFAULT NOTICE

shall have the meaning set forth in AA 20.3;

DISPUTE

means any dispute, controversy or claim between the PARTIES arising out of or in connection with the TERMINAL USE AGREEMENT (including any dispute as to its formation, validity or termination);

DISPUTE NOTICE

shall have the meaning set forth in AA 37.1;

DISPUTE RESOLUTION COMMITTEE

shall have the meaning set forth in AA 38.1;

EARLY LNG VESSEL

shall have the meaning set forth in AA 8.8(a)(iii);

EFFECTIVE DATE	means the date a TERMINAL USE AGREEMENT is entered into between the relevant PARTIES
ELECTRONIC COMMUNICATION SYSTEM	means a private, password-protected electronic communications system for OPERATOR and CAPACITY USERS;
ENERGY COMMISSION	means Suruhanjaya Tenaga, the Energy Commission established under the Energy Commission Act 2001;
ENTIRE SERVICE TRANSFER EFFECTIVE TIME	shall have the meaning set forth in AA 26.4;
ESTIMATED TIME OF ARRIVAL or ETA	shall have the meaning set forth in AA 8.2(a);
EVENT OF FORCE MAJEURE	shall have the meaning set forth in AA 22.1;
EXPANSION PLAN	shall have the meaning set forth in AA 3.4(e);
EXPERT	shall have the meaning set forth in AA 37.2;
FACILITY OPERATING PARAMETERS	means the parameters under which the RECEIVING FACILITY is to operate and shall be as specified in Schedule 5;
FAHRENHEIT	means the temperature scale where thirty-two degrees Fahrenheit (32.0°F) is equal to zero degrees Celsius (0.0°C) and a temperature interval of one degree Fahrenheit (1°F) is equal to an interval of five-ninths degree Celsius (5/9°C);
FEE	shall have the meaning set forth in AA 5.1;
FIFTH NOTICE	means the notice given pursuant to AA 8.2(f);
FIRST NOTICE	means the notice given pursuant to AA 8.2(a);
FOURTH NOTICE	means the notice given pursuant to AA 8.2(e);
FORECAST UNDERTAKE EVENT	shall have the meaning set forth in AA 7.12(e);

GAS DAY	means the period of time beginning at 0600 hours on any calendar day and ending at 0600 hours on the immediately following calendar day, and the date of such day shall be the date of the calendar day on which it begins;
GAS SUPPLY ACT	means the Act 501;
GIGAJoule or GJ	means 1,000,000 joules of NATURAL GAS;
GOVERNMENTAL AUTHORITY	means any judicial, legislative, administrative, executive or other national, state, regional, municipal or local authority, ministry, department or any administrative agency, office, organisation or authority;
GROSS HEATING VALUE	means the energy produced from the complete combustion of one (1) cubic meter of GAS with air, at a temperature of fifteen (15) degrees Celsius and at an absolute pressure of one hundred one and three hundred twenty five thousandths (101.325) kPa, with the GAS free of all water vapour, the products of combustion cooled at a temperature of fifteen (15) degrees Celsius and the water vapour formed by combustion condensed to the liquid state expressed in MJ per cubic meter (MJ/m ³);
INDEPENDENT SURVEYOR	means an independent surveyor appointed pursuant to Schedule 2;

INSOLVENCY EVENT

means, in respect of a PARTY:

- (a) such PARTY is declared bankrupt or is declared to have a similar legal status affecting the rights of creditors generally; or
- (b) such PARTY is unable to pay its debts as they become due; or
- (c) such PARTY makes an assignment for the benefit of its creditors; or
- (d) a receiver is appointed for a substantial part of such the PARTY'S assets; or
- (e) a court order is made or an effective resolution is passed for the dissolution, liquidation, or winding up the reorganization under any bankruptcy law of the PARTY; or
- (f) such PARTY is dissolved, liquidated, wound up, or its existence is otherwise terminated (other than pursuant to a consolidation, amalgamation or merger).

INTER-CAPACITY USER AGREEMENT

means the agreement between OPERATOR and CAPACITY USERS substantially in the form attached at Schedule 12;

INTERNAL GAS CONSUMPTION or IGC

means the

- (a) NATURAL GAS consumed in the LNG TERMINAL FACILITY:
 - (i) as pilot flare and sweep gas; and
 - (ii) for flaring (if any) and venting,as measured or calculated for all purposes of operation, MAINTENANCE and safety; and
- (b) UNACCOUNTED GAS in the LNG TERMINAL FACILITY.

INTERNATIONAL LNG
TERMINAL STANDARDS

means, to the extent not inconsistent with the express requirements of this ACCESS ARRANGEMENT or APPLICABLE LAWS and taking into account local physical conditions, the international standards and practices applicable to the design, construction, equipment, operation and maintenance of LNG receiving and regasification terminals, established by the following (such standards to apply in the following order of priority):

- (a) a GOVERNMENTAL AUTHORITY having jurisdiction over OPERATOR as the owner and/or operator of the RECEIVING FACILITY; and
- (b) any internationally recognised non-governmental agency or organisation, including the Society of International Gas Tankers and Terminal Operators (SIGTTO), Oil Companies International Marine Forum (OCIMF) and The International Group of LNG Importers (GIIGNL), with whose standards and practices it is customary for REASONABLE AND PRUDENT OPERATORS of LNG receiving and regasification terminals to comply;

INTERNATIONAL LNG
VESSEL STANDARDS

means, to the extent not inconsistent with the express requirements of this ACCESS ARRANGEMENT or APPLICABLE LAWS, the international standards and practices applicable to the ownership, design, construction (including the International Code for the Construction and Equipment of Ships Carrying Liquefied Gases in Bulk), equipment, operation and maintenance of LNG vessels established by the following (such standards to apply in the following order of priority):

- (a) a GOVERNMENTAL AUTHORITY;
- (b) the International Maritime Organisation; and
- (c) the Society of International Gas Tankers and Terminal Operators (SIGTTO) and any other internationally recognised non-governmental agency or organisation, including Oil Companies International Marine Forum (OCIMF), the Permanent International Association of Navigation Congresses ("PIANC") and the International Association of Classification Societies,

provided that, in the case of (b) and (c) above, it is customary for REASONABLE AND PRUDENT OPERATORS of LNG vessels to comply with the standards and practices of such organisation, society or non-governmental agency;

INTERRUPTIBLE
REGASIFICATION FEE

means, in respect of any CONTRACT MONTH, the monthly fee calculated in accordance with AA 5.3;

INTERRUPTIBLE
REGASIFICATION
SERVICE

shall have the meaning set forth in AA 7.11(g)(iii);

INTERRUPTIBLE
REGASIFICATION TARIFF

means the tariff referred to in AA 5.3;

IRB

shall have the meaning set forth in AA 17.10(b);

JETTY USAGE
AGREEMENT

means the agreement entered into between OPERATOR and Pengerang Terminals (Two) Sdn. Bhd. on 28 February 2017 for OPERATOR'S use of the LNG JETTY SUBSTRUCTURE;

JOHOR PORT AUTHORITY

means the regulatory body that regulates activities and development of private jetties within the port water limits as described in Schedule 7;

LATE LNG VESSEL	shall have the meaning set forth in AA 8.8(a)(ii);
LNG	means NATURAL GAS in its liquid state at or below its boiling point at or near atmospheric pressure;
LNG JETTY SUBSTRUCTURE	means the piles and all related equipment as further described in paragraph B of Schedule 5;
LNG JETTY TOPSIDE FACILITY	means the LNG unloading line, vapour return line, LNG recirculation line, LNG unloading arms, vapour return arms and all other related equipment as further described in paragraph A of Schedule 5;
LNG RECEIPT POINT	means the point at the LNG JETTY TOPSIDE FACILITY at which the flange coupling of the LNG JETTY TOPSIDE FACILITY delivery line joins the flange coupling on the LNG unloading manifold on board an LNG VESSEL;
LNG RELOAD DELIVERY POINT	means the point at the LNG JETTY TOPSIDE FACILITY at which the flange coupling of the LNG JETTY TOPSIDE FACILITY delivery line joins the flange coupling on the LNG loading manifold on board an LNG VESSEL;
LNG SPECIFICATIONS	means the specifications set out in Schedule 3;
LNG STORAGE TANKS	means the storage tanks forming part of the RECEIVING FACILITY and utilized for the storage of LNG that is received from LNG VESSELS as further described in paragraph C of Schedule 5;
LNG TERMINAL FACILITY	means the: <ul style="list-style-type: none"> (a) LNG STORAGE TANKS; (b) REGASIFICATION UNIT; (c) SEND OUT GAS METERING STATION; and (d) LNG JETTY TOPSIDE FACILITY, all as further described in Schedule 5.
LNG VESSEL	means an ocean going vessel suitable for transporting LNG that CAPACITY USER uses or procures the use of for transportation of LNG to the RECEIVING FACILITY;
LNG VESSELS SPECIFICATIONS	means the specifications set out in Schedule 1;

LONG TERM CAPACITY USER	means any CAPACITY USER in respect of which the TERM of its TERMINAL USE AGREEMENT is more than twelve (12) months;
LOST GAS	means NATURAL GAS (not being UNACCOUNTED GAS) that is consumed, lost and/or unaccounted for in the LNG TERMINAL FACILITY;
MAINTENANCE	means any inspection, maintenance, repair or modification (in the course of maintenance or repair) of the RECEIVING FACILITY, including any SCHEDULED MAINTENANCE and UNSCHEDULED MAINTENANCE;
MANDATORY REGULATORY SHUTDOWN	means mandatory shutdown of the RECEIVING FACILITY from time to time as required by APPLICABLE LAWS for the purpose of inspecting the RECEIVING FACILITY and undertaking any repairs, rectification or modification to the RECEIVING FACILITY required as a result of such inspection;
MASTER	shall have the meaning set forth in AA 6.1(b)(iii)(D) in respect of any LNG VESSEL;
MAXIMUM ALLOWED BERTHING SLOTS	shall, with respect to each CAPACITY USER for a CONTRACT YEAR, be the number of berthing slots calculated as follows: $\text{MAXIMUM ALLOWED BERTHING SLOTS} = A / B,$ <p>Where:</p> <p>"A" is CAPACITY USER'S ACQ for such CONTRACT YEAR; and</p> <p>"B" is 145,000 m³;</p> <p>As adjusted for any PARTIAL SERVICE TRANSFER;</p>
MAXIMUM SEND OUT RATE	means, for any GAS DAY, the REGASIFICATION SERVICES ENTITLEMENT in respect of the CONTRACT YEAR divided by the number of GAS DAYS in that CONTRACT YEAR;
MEASUREMENT RULES	shall be as outlined in Schedule 2;
MINIMUM HEEL REQUIREMENT	means 32,570 m ³ of the volume of LNG required to be retained in the LNG STORAGE TANKS and deadstock in piping/other equipment based on LNG TERMINAL FACILITY design ;

MINIMUM SEND OUT RATE

means in relation to any CAPACITY USER, its pro rata share (calculated on the basis of such CAPACITY USER'S SERVICES ENTITLEMENT expressed as a proportion of the aggregate of all CAPACITY USERS' SERVICES ENTITLEMENT) of the equivalent of:

- (a) 104 tonnes/hour during any period when no LNG is being unloaded/reloaded from an LNG VESSEL (ignoring for the purpose of calculating CAPACITY USER'S pro rata share, the STORAGE SERVICES ENTITLEMENT and the RELOAD SERVICES ENTITLEMENT); or
- (b) 177 tonnes/hour when LNG is being unloaded from LNG VESSEL; or
- (c) 264 tonnes/hour when LNG is being reloaded to LNG VESSEL (ignoring for the purpose of calculating CAPACITY USER'S pro rata share, the REGASIFICATION SERVICES ENTITLEMENT),

the above amounts being the lowest send out rates achievable by the RECEIVING FACILITY without flaring provided that OPERATOR may, in its discretion following the signature of a TERMINAL USE AGREEMENT with a CAPACITY USER with STORAGE SERVICES ENTITLEMENT and/or RELOAD SERVICES ENTITLEMENT, notify CAPACITY USER of revisions to paragraph (b) and/or (c) above.

MMBTU

means one million (1,000,000) BTU;

MMS

means MISC Maritime Services Sdn Bhd (Company No. 1288495D) which is the port operator and pilotage service provider which is responsible for the navigation, safety and traffic regulation of all vessels navigating within the port limits as described in Schedule 7, and includes its successors and assigns;

NATURAL GAS

means any hydrocarbons or mixture of hydrocarbons derived from the conversion of LNG received by OPERATOR at the LNG RECEIPT POINT from its liquid state to a gaseous state consisting predominantly of methane and other hydrocarbons and non-combustible gases all of which are in substantially gaseous state under STANDARD CONDITIONS;

NATURAL GAS DELIVERY POINT	means the flange connection located downstream of the last block valves at RAPID Tee-off point of the PGU battery limit where the SEND OUT GAS is delivered to the PGU NETWORK;
NOTICE OF READINESS	shall have the meaning set forth in AA 8.3(a);
Oil Company International Marine Forum (“OCIMF”)	means a voluntary association of oil companies having an interest in the shipment and terminalling of crude oil and oil products;
OFF-SPECIFICATION GAS	shall have the meaning set forth in AA 12.7(a);
OFF-SPECIFICATION LNG	means LNG which does not conform with the LNG SPECIFICATIONS;
OPEN SEASON INVITATION	shall have the meaning set forth in AA 3.4(b);
OPERATOR EVENT OF DEFAULT	shall have the meaning set forth in AA 20.1;
OTHER TERMINAL USE AGREEMENT	means any agreement between OPERATOR and a CAPACITY USER (excluding CUSTOMER) for the provision of SERVICES;
PARTIAL SERVICE TRANSFER	shall have the meaning set forth in AA 26.6;
PARTIAL SERVICE TRANSFER APPROVAL	means a letter substantially in the form set out in Schedule 13;
PARTIAL SERVICE TRANSFER EFFECTIVE TIME	means the time specified in the relevant PARTIAL SERVICE TRANSFER APPROVAL as such;
PARTIAL SERVICES TRANSFER TERMINATION TIME	means the time specified as such in the relevant PARTIAL SERVICES TRANSFER APPROVAL as such;
PARTIAL SHUTDOWN	means the partial shutdown of the RECEIVING FACILITY in accordance with the ANNUAL MAINTENANCE PROGRAMME;
PARTICIPATING CAPACITY USER	means a CAPACITY USER or PROSPECTIVE CAPACITY USER who responds to an OPEN SEASON INVITATION with a request for new RECEIVING FACILITY CAPACITY;
PARTIES	means in relation to any TERMINAL USE AGREEMENT, the parties to such TERMINAL USE AGREEMENT;

PENGERANG DEEPWATER TERMINAL	means the terminal within the port limits illustrated in Schedule 7;
PERMITTED BERTH OCCUPANCY TIME	means, in respect of an LNG VESSEL, the period specified in AA 8.5(a) for an LNG VESSEL of the same maximum cargo capacity (as that period may be extended pursuant to AA 8.5(e));
PETRONAS MARITIME INSPECTION	means the inspection as outlined in AA 6.3;
PGU NETWORK	means the Peninsular Gas Utilisation Transmission System;
PGU NETWORK CODE	means the terms and conditions for the utilisation of the PGU NETWORK;
PILOT	means any person engaged by CAPACITY USER to come on board an LNG VESSEL to assist the MASTER in pilotage, berthing, mooring and unmooring of such LNG VESSEL;
PILOT BOARDING STATION	means the location off the RECEIVING FACILITY in the designated anchorage area at which PILOTS customarily board the LNG VESSEL;
PORT AND MARINE SERVICES	means any tugs pilots and other harbour services required by CAPACITY USER;
PORT AND MARINE SERVICES CHARGES	means charges imposed for PORT AND MARINE SERVICES including all harbour dues;
PRELIMINARY ANNUAL OPERATION SCHEDULE	shall have the meaning set forth in AA 7.4(a)(i);
PREVIOUS PORT	means the port at which an LNG VESSEL calls, immediately prior to calling at the RECEIVING FACILITY;
PROJECT	means the development, construction, commissioning, operation, maintenance, and financing of the LNG regasification and storage facilities project to be located within the PENGERANG REEF WATER TERMINAL (PRWT) in Pengerang Johor, Malaysia;
PROPOSED AA CHANGE	shall have the meaning set forth in AA 29.1;
PROPOSED TRANSFEREE	shall have the meaning set forth in AA 26.3;

PROSPECTIVE CAPACITY USER means a person:

- (a) that does not hold (but intends to hold) a licence under the GAS SUPPLY ACT to import gas into a regasification terminal in Malaysia (save and except where such person intends to subscribe for only RELOAD SERVICES from the OPERATOR) and has not entered into a TERMINAL USE AGREEMENT with OPERATOR; or
- (b) that holds a licence under the GAS SUPPLY ACT to import gas into a regasification terminal in Malaysia (save and except where such person intends to subscribe for only RELOAD SERVICES from the OPERATOR) but has not entered into a TERMINAL USE AGREEMENT with OPERATOR; or
- (c) that has or will have title to LNG at the time it enters the RECEIVING FACILITY at the LNG RECEIPT POINT;

REASONABLE AND PRUDENT OPERATOR means a person seeking in good faith to perform its contractual obligations and in so doing and in the general conduct of its undertaking, exercising that degree of skill, diligence, prudence, competence and foresight which would be reasonably and ordinarily expected from a skilled and experienced operator engaged in the same type of understanding under the same or similar circumstances and conditions;

REASONABLE ENDEAVOURS means, for any action required to be made, tried, or taken by a PARTY under a TERMINAL USE AGREEMENT, the efforts that a prudent person would undertake to protect its own interests, including commercial interests, taking into account the conditions affecting the action, including the amount of notice to act, recognition of the need to act, the duration and type of action, the competitive environment in which the action happens, and the projected benefit, cost, and risk to the PARTY required to take the action;

RAPID COMPLEX means the RAPID refinery and petrochemical integrated development project and the Pengerang Co-generation Plant;

RECEIVING FACILITY means the:

- (a) LNG TERMINAL FACILITY; and
- (b) LNG JETTY SUBSTRUCTURE.

RECEIVING FACILITY CAPACITY	means the capacity of the RECEIVING FACILITY as may be determined by OPERATOR in accordance with guidelines published by Energy Commission from time to time, taking into account (amongst other things): <ul style="list-style-type: none"> (a) the loading and unloading capacity of the LNG JETTY TOPSIDE FACILITY and LNG JETTY SUBSTRUCTURE, and maximum number and duration of BERTHING SLOTS; (b) capacity of the LNG STORAGE TANKS; (c) regasification capacity; (d) SEND OUT GAS capacity; and (e) available pipeline capacity at the PGU NETWORK entry point;
REFERENCE GAS PRICE	means, in relation to any period, WAP Bintulu or any other price approved by the ENERGY COMMISSION;
REGASIFICATION CAPACITY USER	means a person who has purchased the right to REGASIFICATION SERVICES under the terms of a TERMINAL USE AGREEMENT;
REGASIFICATION FEE	means, in respect of any CONTRACT MONTH, the monthly fee calculated in accordance with AA 5.2;
REGASIFICATION SERVICES	means: <ul style="list-style-type: none"> (a) the receipt from LNG VESSELS of LNG at the LNG RECEIPT POINT into the RECEIVING FACILITY; (b) the regasification of the LNG at the REGASIFICATION UNIT; (c) the delivery of SEND OUT GAS to CAPACITY USER at the NATURAL GAS DELIVERY POINT; and (d) the scheduling, administrative and other services directly related to the LNG including but not limited to providing BERTHING SLOTS up to the MAXIMUM ALLOWED BERTHING SLOTS.;
REGASIFICATION SERVICES ENTITLEMENT	shall, with respect to each REGASIFICATION CAPACITY USER, be as set out in the TERMINAL USE AGREEMENT of such REGASIFICATION CAPACITY USER;
REGASIFICATION TARIFF	means the tariff referred to in AA 5.2;

REGASIFICATION UNIT	means the regasification unit as further described in paragraph D of Schedule 5;
RELATED DISPUTE	means any dispute controversy or claim arising out of or in connection with any OTHER TERMINAL USE AGREEMENT entered into by OPERATOR in relation to the PROJECT (including any dispute as to its formation) or the INTER-CAPACITY USER AGREEMENT, which raises substantially the same or connected factual and/or legal issues as any DISPUTE under the TERMINAL USE AGREEMENT;
RELOAD FEE	has the meaning given in AA 5.4;
RELOAD SERVICES	means: <ul style="list-style-type: none"> (a) the reloading of the LNG at the LNG RELOAD DELIVERY POINT from the storage in the LNG STORAGE TANKS to the LNG VESSEL; and (b) the scheduling, administrative and other services directly related to the LNG;
RELOAD SERVICES ENTITLEMENT	shall, with respect to each CAPACITY USER, be as set out in the TERMINAL USE AGREEMENT of such CAPACITY USER;
RELOAD TARIFF	shall, with respect to each CAPACITY USER, be as set out in the TERMINAL USE AGREEMENT of such CAPACITY USER;
REQUESTING CAPACITY USER	has the meaning given in AA 27.1;
REVISED BERTHING TIME	has the meaning given in AA 8.3(i);
SCHEDULED DATE OF ARRIVAL	means, for any LNG VESSEL CARGO or BERTHING SLOT, the period between 0000 hours to 2359 hours during any day on which such LNG VESSEL is scheduled to arrive at the PILOT BOARDING STATION as specified in the issued ANNUAL OPERATION SCHEDULE or most recent THREE MONTH OPERATION SCHEDULE;
SCHEDULED MAINTENANCE	means all MAINTENANCE that is described in an ANNUAL MAINTENANCE PROGRAMME;
SCHEDULED DAILY GAS QUANTITY	shall have the meaning given in AA 7.11(a)(i);
SCHEDULED MONTH	shall have the meaning given in AA 7.11(a)(i);

SCHEDULED MONTHLY GAS QUANTITY	shall have the meaning given in AA 7.11(a)(i);
SECOND NOTICE	means the notice given pursuant to AA 8.2(c);
SEND OUT CAPACITY	means the send out capacity of the RECEIVING FACILITY at any relevant time;
SEND OUT GAS	means NATURAL GAS resulting from LNG that has been processed within the LNG TERMINAL FACILITY for delivery as NATURAL GAS at the NATURAL GAS DELIVERY POINT;
SEND OUT GAS METERING STATION	means all such equipment for the purposes of measuring and testing SEND OUT GAS which are located at the LNG TERMINAL FACILITY, as further specified in Schedule 5;
SEND OUT GAS SPECIFICATIONS	shall have the meaning set forth in Schedule 4;
SERVICE COMMENCEMENT DATE	means, with respect to each CAPACITY USER, the date from which OPERATOR is obliged to perform SERVICES for such CAPACITY USER as specified in the relevant SPECIFIC TERMS AND CONDITIONS;
SERVICES	shall have the meaning set forth in AA 4.1;
SERVICES ENTITLEMENT	means, in relation to any CAPACITY USER, its REGASIFICATION SERVICES ENTITLEMENT, STORAGE SERVICES ENTITLEMENT and RELOAD SERVICES ENTITLEMENT;
SHORT TERM AGREEMENT	means any TERMINAL USE AGREEMENT between OPERATOR and a SHORT TERM CAPACITY USER for the provision of SHORT TERM SERVICES;
SHORT TERM CAPACITY	means capacity as referred to in AA 3.2(a);
SHORT TERM CAPACITY USER	means any CAPACITY USER with which OPERATOR has agreed to provide SHORT TERM SERVICES in accordance with its TERMINAL USE AGREEMENT;
SHORT TERM SERVICES	means any SERVICES (including for the avoidance of doubt any SERVICES to be provided on a spot basis) to be provided by OPERATOR to CAPACITY USER pursuant to AA 3.2, which are to be for a duration of less than twelve (12) months;

SIRE ACCREDITED INSPECTOR	means an inspector qualified and certified by OCIMF under the Ship Inspection Report Exchange (SIRE) Programme to inspect an LNG VESSEL for the purpose of generating an inspection report for inclusion in OCIMF's Ship Inspection Report Programme;
STANDARD CONDITIONS	means a temperature of fifteen point six degrees Celsius (15.6°C) (measured with a mercury thermometer) and an absolute pressure of one point zero one three two five (1.01325) bar;
STANDARD CUBIC FOOT or SCF	is a measure of quantity of NATURAL GAS, equal to a cubic foot of volume at sixty degrees FAHRENHEIT (60°F) (fifteen and six tenths degrees CELCIUS (15.6°C) and fourteen point six ninety-six (14.696) psia (one (1) atm or one hundred and one point three twenty-five (101.325) KPa) of pressure);
STORAGE FEE	has the meaning given in AA 5.4;
STORAGE SERVICES	means: <ul style="list-style-type: none"> (a) the receipt from LNG VESSELS of LNG at the LNG RECEIPT POINT into the RECEIVING FACILITY; (b) the storage of LNG in the LNG STORAGE TANKS; and (c) the scheduling, administrative and other services directly related to the LNG;
STORAGE SERVICES ENTITLEMENT	shall, with respect to each CAPACITY USER , be as set out in the TERMINAL USE AGREEMENT of such CAPACITY USER;
STORAGE TARIFF	shall, with respect to each CAPACITY USER , be as set out in the TERMINAL USE AGREEMENT of such CAPACITY USER;
SUBSCRIBED CAPACITY	means, for the purposes of determining AVAILABLE CAPACITY, any RECEIVING FACILITY CAPACITY which has been committed under a TERMINAL USE AGREEMENT;
SUSPENSION EVENT	shall have the meaning set forth in AA 19.1;
TANK INVENTORY CAPACITY	means 400,000m ³ in total;

TAX OR TAXES	shall include but not be limited to any customs, income, profit, withholding, franchise, excess profits, royalties, other taxes, excises, fees, duties, levies, sales and use taxes and value added taxes, personal property taxes, employment taxes, charges and all other assessments, which may or may not hereafter be enacted, levied or imposed, directly or indirectly, by law, regulations or trade union contracts which may be imposed by a GOVERNMENTAL AUTHORITY and shall include penalties, interest and fines in respect thereof;
TERM	shall have the meaning set forth in the relevant TERMINAL USE AGREEMENT;
TERMINAL INFORMATION BOOKLET	means the booklet which contains the rules and requirements that need to be complied with by all LNG VESSELS in order to deliver LNG to the RECEIVING FACILITY with the objective of ensuring good order, health, safety, security, protection of life and property and sound environmental practices;
THREE MONTH NOMINATION SCHEDULE	shall have the meaning set forth in AA 7.7(a);
THREE MONTH OPERATION SCHEDULE	shall be the schedule agreed or determined pursuant to AA 7.8(c) or 7.8(e), as the same may be revised pursuant to this ACCESS ARRANGEMENT;
THIRD NOTICE	means the notice given pursuant to AA 8.2(d);
TOTAL REGASIFICATION CAPACITY	means the total capacity of the REGASIFICATION UNIT to regasify LNG and redeliver NATURAL GAS to the NATURAL GAS DELIVERY POINT with respect to any GAS DAY during a CONTRACT YEAR;
TOTAL SHUTDOWN	means the total shutdown of the RECEIVING FACILITY;
TPA CODE	means the Third Party Access Code for Malaysian Regasification Terminals established by the ENERGY COMMISSION pursuant to the GAS SUPPLY ACT, as the same is amended, supplemented or replaced from time to time;
UIOLI PERIOD	shall have the meaning set forth in AA 27.2;
UNACCOUNTED GAS	means (a) NATURAL GAS which is lost and not measured in the LNG TERMINAL FACILITY due to venting and leakage, and (b) NATURAL GAS unaccounted for in the LNG TERMINAL FACILITY due to measurement errors;

UNAVAILABLE	the RECEIVING FACILITY is UNAVAILABLE during any hour during which the RECEIVING FACILITY is not able to provide any SERVICES for any reason including SCHEDULED MAINTENANCE, but excluding: <ul style="list-style-type: none"> (a) an act or omission of any CAPACITY USER (or its agents, contractors or subcontractors); or (b) an EVENT OF FORCE MAJEURE; or (c) MANDATORY REGULATORY SHUTDOWN;
UNDER-USING CAPACITY USER	shall have the meaning set forth in AA 27.1 (a);
UNSCHEDULED MAINTENANCE	means MAINTENANCE which is required for safety, operational reasons (in OPERATOR'S sole discretion), and which in any case has not been included in the ANNUAL MAINTENANCE PROGRAMME;
UNSUBSCRIBED CAPACITY	means, for the purposes of determining AVAILABLE CAPACITY, any RECEIVING FACILITY CAPACITY which has not been committed under a TERMINAL USE AGREEMENT;
USED LAYTIME	means the period calculated pursuant to AA 8.4(e) for both unloading and reloading activities; and
WILFUL MISCONDUCT / GROSS NEGLIGENCE	means: <ul style="list-style-type: none"> (a) any act or omission (whether sole, joint or concurrent) by the relevant Party which was intended to cause, or which was in reckless disregard of or wanton indifference to, harmful consequences such Party knew, or should have known, such act or failure would have on the safety or property or interests of another Party; or (b) any act or omission (whether sole, joint, or concurrent) by the relevant Party which was a deliberate and intentional breach of such Party's obligations under the TERMINAL USE AGREEMENT.

1.2 Construction and Interpretation

- (a) Unless a contrary indication appears, any reference in the TERMINAL USE AGREEMENT to:
 - (i) any PARTY shall be construed so as to include its successors in title and permitted assigns;

- (ii) words importing the singular only also include the plural and vice versa where the context so requires;
- (iii) an agreement or any other instrument is a reference to such agreement or other instrument as amended, supplemented or novated from time to time in accordance with, and subject to, any requirements of such agreement and (in the case of a reference to any other instrument) that instrument;
- (iv) a person includes any individual, firm, company, corporation, unincorporated organisation, government, state or agency of a state or any association, trust or partnership (whether or not having separate legal personality) or any other entity;
- (v) a regulation includes any regulation, rule, official directive, request or guideline (whether or not having the force of law but where it does not have the force of law, being one that a REASONABLE AND PRUDENT OPERATOR would comply with) of any governmental, intergovernmental or supranational body, agency, department or regulatory, or other authority or organisation;
- (vi) a provision of any statute, law, statutory instrument or regulation is, a reference to that provision as amended or re-enacted or consolidated from time to time as far as such amendment, re-enactment or consolidation applies or is capable of applying to any transactions entered into under the TERMINAL USE AGREEMENT;
- (vii) a time of day is a reference to Malaysian time;
- (viii) words of any gender include each other gender;
- (ix) a period of time shall be based on, and computed according to, the Gregorian calendar;
- (x) any capitalised words, terms phrases and abbreviations used specifically in any schedule to this ACCESS ARRANGEMENT shall have the meanings set forth in such schedule to this ACCESS ARRANGEMENT; and
- (xi) "include" and "including" shall mean include or including without limiting the generality of the description preceding such term and are used in an illustrative sense and not a limiting sense.

(b) Headings are for ease of reference only.

1.3 Legal Framework

- (a) OPERATOR and CAPACITY USER hereby acknowledge that:
 - (i) the TPA CODE (and any other relevant codes developed and issued under the GAS SUPPLY ACT) shall apply to the REGASIFICATION FACILITY; and

- (ii) OPERATOR and each CAPACITY USER must comply with the TPA CODE (and any other relevant codes developed and issued under the GAS SUPPLY ACT).
- (b) In the event of any conflict between the terms of this ACCESS ARRANGEMENT and the TPA CODE (and any other relevant codes developed and issued under the GAS SUPPLY ACT), either OPERATOR or CAPACITY USER may submit an AA CHANGE REQUEST pursuant to AA 29.2 below.

2.0 ACCESS TO SERVICES

2.1 Subject to the provisions set out in this AA 2.0 and AA 3.0, access to the SERVICES at the RECEIVING FACILITY shall be granted in an impartial manner to any APPLICANT, provided that such APPLICANT satisfies or will satisfy the following conditions ("ACCESS REQUIREMENTS") at the time OPERATOR allocates any AVAILABLE CAPACITY to the APPLICANT pursuant to AA 3.3(b):

- (a) APPLICANT shall be licensed under the GAS SUPPLY ACT to import gas into a regasification terminal in Malaysia; save and except where the APPLICANT subscribes for only RELOAD SERVICES from the OPERATOR.
- (b) the APPLICANT has signed, or adhered in accordance with its terms to, the INTER-CAPACITY USER AGREEMENT and the INTER-CAPACITY USER AGREEMENT is effective as between the APPLICANT and the other parties to the INTER-CAPACITY USER AGREEMENT; and
- (c) the APPLICANT shall meet the credit requirements as set out further in Schedule 10;

provided that OPERATOR may waive any of the ACCESS REQUIREMENTS (with the exception of AA 2.1(a) and (b)) by giving notice to an APPLICANT.

2.2 OPERATOR shall not provide or agree to provide SERVICES to any APPLICANT or CAPACITY USER:

- (a) other than on terms based on this ACCESS ARRANGEMENT; or
- (b) which would have an adverse effect on another CAPACITY USER'S rights to the SERVICES under such other CAPACITY USER'S TERMINAL USE AGREEMENT, which is not expressly contemplated under this ACCESS ARRANGEMENT; or
- (c) if such APPLICANT or CAPACITY USER is not party to the INTER-CAPACITY USER AGREEMENT.

2.3 INFORMATION MANAGEMENT

OPERATOR shall operate and maintain:

- (a) a public website; and
- (b) to the extent OPERATOR deems it necessary, a separate ELECTRONIC COMMUNICATIONS SYSTEM,

on which OPERATOR shall publish and manage information in relation to the RECEIVING FACILITY which OPERATOR deems to be appropriate, provided that OPERATOR shall publish on its website current copies of this ACCESS ARRANGEMENT and the information set out in AA 3.1.

3.0 CAPACITY ALLOCATION MECHANISM

3.1 RECEIVING FACILITY CAPACITY

OPERATOR shall promptly publish to, and at all times maintain up to date on its website, an accurate status of the RECEIVING FACILITY CAPACITY. The information to be published pursuant to this AA 3.1 shall be on a monthly basis and shall include:

- (a) the amount of capacity ("AVAILABLE CAPACITY"), comprising (without double-counting):
 - (i) UNSUBSCRIBED CAPACITY; and
 - (ii) SHORT TERM CAPACITY which is available for subscription;
- (b) the amount of SUBSCRIBED CAPACITY, including any SUBSCRIBED CAPACITY made available for transfer from CAPACITY USER pursuant to AA 26.3 or AA 26.7(a);
- (c) in respect of UNSUBSCRIBED CAPACITY, OPERATOR shall publish the number of available BERTHING SLOTS in each CONTRACT MONTH and, if known, the timing of such BERTHING SLOTS;
- (d) in respect of SHORT TERM CAPACITY, OPERATOR shall publish:
 - (i) the commencement date and duration of the relevant BERTHING SLOT(s);
 - (ii) the maximum volume of LNG which can be loaded or unloaded during the relevant BERTHING SLOT(s);
 - (iii) the due date and time for submission of ACCESS REQUESTS for such SHORT TERM CAPACITY;
 - (iv) the latest date by which any such ACCESS REQUEST shall be accepted by OPERATOR; and
 - (v) the delivery period for any SEND OUT GAS and an indicative and non-binding SEND OUT GAS redelivery profile.

3.2 SHORT TERM CAPACITY

- (a) Within fourteen (14) days of OPERATOR publishing the ANNUAL OPERATION SCHEDULE in accordance with AA 7.6, OPERATOR shall determine in its sole discretion and publish on its website whether there will be any capacity (up to the TANK INVENTORY CAPACITY) for it to provide SHORT TERM SERVICES during the following CONTRACT YEAR, provided, always, that:

- (i) the provision of such SHORT TERM SERVICES shall not adversely impact other CAPACITY USER'S firm rights under its TERMINAL USE AGREEMENT; and
 - (ii) the unloading or reloading of CARGOES relating to such SHORT TERM SERVICES will not adversely impact, interfere or delay with the unloading or reloading of the other LNG VESSELS on the basis of the ANNUAL OPERATION SCHEDULE.
- (b) Following its determination in accordance with AA 3.2(a), OPERATOR shall update any information previously published in relation to such SHORT TERM SERVICES as soon as reasonably practicable.

3.3 **Subscription for AVAILABLE CAPACITY**

- (a) Any person who meets the ACCESS REQUIREMENTS in accordance with AA 2.1, including an existing CAPACITY USER, may become an APPLICANT for AVAILABLE CAPACITY by submitting an ACCESS REQUEST to OPERATOR.

Subject to AA 3.3(b), OPERATOR may allocate any AVAILABLE CAPACITY to one or more APPLICANTS by entering into TERMINAL USE AGREEMENT(S) with such CAPACITY USERS with respect to such AVAILABLE CAPACITY, subject always to the entry into such TERMINAL USE AGREEMENT(S) not preventing OPERATOR from fulfilling its obligations under the TPA CODE.

- (b) ACCESS REQUESTS for AVAILABLE CAPACITY shall be processed and allocated by OPERATOR on a "first come, first served" basis no later than thirty (30) days after OPERATOR'S receipt of the relevant ACCESS REQUEST, provided that, in the event OPERATOR is processing more than one ACCESS REQUEST at any point in time, OPERATOR shall allocate AVAILABLE CAPACITY on the following priority basis:
- (i) ACCESS REQUESTS to become a LONG TERM CAPACITY USER starting with the ACCESS REQUESTS with the largest REGASIFICATION SERVICES ENTITLEMENT and working downwards; and
 - (ii) to the extent there is any remaining capacity after (i) above, ACCESS REQUESTS by SHORT TERM CAPACITY USERS starting with CAPACITY USERS applying for the SERVICES ENTITLEMENT which most closely matches the terms being offered and working downwards.
- (c) No later than one (1) day after entering into a TERMINAL USE AGREEMENT pursuant to this AA 3.3, OPERATOR shall update its ELECTRONIC COMMUNICATION SYSTEM accordingly.

3.4 **OPEN SEASON**

- (a) When required by the TPA CODE, OPERATOR will carry out an "open season" to assess market demand for RECEIVING FACILITY CAPACITY by evaluating the need for new RECEIVING FACILITY CAPACITY and the possibility of an

expansion of the RECEIVING FACILITY. This open season will be carried out in accordance with this AA 3.4, the TPA CODE and any applicable guidelines published by the ENERGY COMMISSION.

- (b) If OPERATOR is required to carry out an open season, OPERATOR will publish on its public website an invitation to CAPACITY USERS and PROSPECTIVE CAPACITY USERS to:
 - (i) apply for new RECEIVING FACILITY CAPACITY, by submitting an application in the form and time period required by OPERATOR; or
 - (ii) relinquish existing RECEIVING FACILITY CAPACITY, by submitting an application in the form and time period required by OPERATOR,("OPEN SEASON INVITATION").
- (c) OPERATOR will also circulate the OPEN SEASON INVITATION to all CAPACITY USERS.
- (d) OPERATOR will promptly assess any responses received to the OPEN SEASON INVITATION. If OPERATOR concludes that any request for new RECEIVING FACILITY CAPACITY can be met without an expansion of the RECEIVING FACILITY, OPERATOR will allocate the available capacity to the PARTICIPATING CAPACITY USERS in accordance with the CAPACITY ALLOCATION GUIDELINES.
- (e) If OPERATOR concludes that any request for new RECEIVING FACILITY CAPACITY cannot be met without an expansion of the RECEIVING FACILITY, OPERATOR will develop a detailed plan for meeting that unmet RECEIVING FACILITY CAPACITY in accordance with the TPA CODE ("EXPANSION PLAN").
- (f) The EXPANSION PLAN will be approved by the ENERGY COMMISSION in accordance with the TPA CODE. OPERATOR will provide a copy of the approved EXPANSION PLAN to all PARTICIPATING CAPACITY USERS, provided that OPERATOR may redact from such EXPANSION PLAN any commercially sensitive information or information that is confidential to third parties.
- (g) If a PARTICIPATING CAPACITY USER agrees to the approved EXPANSION PLAN and is required by OPERATOR, in accordance with the EXPANSION PLAN, to register for the proposed additional RECEIVING FACILITY CAPACITY, it must enter into a binding agreement with OPERATOR giving effect to its registration, in the form reasonably required by OPERATOR and approved by the ENERGY COMMISSION.
- (h) OPERATOR will implement and comply with the EXPANSION PLAN. Upon completion of the EXPANSION PLAN, the PARTICIPATING CAPACITY USERS who have executed a binding agreement with OPERATOR as contemplated in AA 1.1(g) will each enter into an agreement with OPERATOR (in the form of the TERMINAL USE AGREEMENT or, where the PARTICIPATING CAPACITY USER is party to an existing TERMINAL USE

AGREEMENT with OPERATOR, an amended TERMINAL USE AGREEMENT), which sets out the terms and conditions on which the PARTICIPATING CAPACITY USER will receive SERVICES in respect of the additional RECEIVING FACILITY CAPACITY.

4.0 SERVICES

4.1 Services to be provided to CAPACITY USER

During each CONTRACT YEAR and subject to the provisions of the TERMINAL USE AGREEMENT, OPERATOR shall make available:

- (a) REGASIFICATION SERVICES up to the REGASIFICATION SERVICES ENTITLEMENT (provided that the REGASIFICATION SERVICES made available in any GAS DAY should not cause the MAXIMUM SEND OUT RATE for that GAS DAY to be exceeded);
- (b) INTERRUPTIBLE REGASIFICATION SERVICES up to the quantity requested by CAPACITY USER and allocated to CAPACITY USER on an interruptible basis pursuant to AA 7.11(g)(iii);
- (c) STORAGE SERVICES up to the STORAGE SERVICES ENTITLEMENT; and
- (d) RELOAD SERVICES up to the RELOAD SERVICES ENTITLEMENT,

including in each case services relating to the measurement and testing of LNG and NATURAL GAS, the maintenance of an inventory tracking and management service, and any other services that are related to the provision of the REGASIFICATION SERVICES, INTERRUPTIBLE REGASIFICATION SERVICES, STORAGE SERVICES and/or RELOAD SERVICES, as applicable (together "SERVICES"). CAPACITY USERS acknowledge that the REGASIFICATION SERVICES are regulated and the AUXILIARY SERVICES are unregulated. CAPACITY USERS further acknowledge that the commercial terms for the provision of any AUXILIARY SERVICES are to be negotiated and agreed between OPERATOR and the relevant CAPACITY USER (on an individual basis) and recorded in such CAPACITY USER's TERMINAL USE AGREEMENT.

4.2 Reduction in SERVICES

If OPERATOR is unable to provide SERVICES to one or more CAPACITY USERS, including as a result of an EVENT OF FORCE MAJEURE and circumstances where OPERATOR may suspend SERVICES pursuant to AA 4.3, OPERATOR shall allocate the available capability of the RECEIVING FACILITY to perform the relevant SERVICES in the following order ("CURTAILMENT ORDER"):

- (a) first, if such inability to provide SERVICES was caused by a particular CAPACITY USER or CAPACITY USERS, the entitlement of such CAPACITY USER or CAPACITY USERS to receive SERVICES will be reduced to the extent of the affected SERVICES, and such reductions will be further allocated pro rata amongst the relevant CAPACITY USERS in accordance with each CAPACITY USER'S relevant SERVICES ENTITLEMENT;

- (b) second, in the event of a reduction in TOTAL REGASIFICATION CAPACITY (which exceeds the quantity of SERVICES curtailed in accordance with AA 4.2(a) above) during any GAS DAY with respect to which INTERRUPTIBLE REGASIFICATION SERVICE has been scheduled, the entitlement of REGASIFICATION CAPACITY USERS to receive INTERRUPTIBLE REGASIFICATION SERVICE will be reduced to the extent required pro rata to the relevant REGASIFICATION CAPACITY USER'S entitlements to receive the affected INTERRUPTIBLE REGASIFICATION SERVICE;
- (c) third, the entitlement of SHORT TERM CAPACITY USERS to receive SHORT TERM SERVICES will be reduced to the extent required, pro rata to the entitlements of such SHORT TERM CAPACITY USERS to receive the affected SHORT TERM SERVICES; and
- (d) fourth, the entitlement of LONG TERM CAPACITY USERS to receive SERVICES will be reduced to the extent required pro rata to the entitlements of such LONG TERM CAPACITY USERS to receive the affected SERVICES.

Notwithstanding AA 4.2(a) to 4.2(d) above, if OPERATOR reduces or curtails the SERVICES ENTITLEMENT of CAPACITY USER due to reasons attributable to OPERATOR'S fault, OPERATOR shall, subject to AA 15.5(a), protect, indemnify, defend and hold harmless CAPACITY USER for the direct costs, losses and expenses reasonably incurred by CAPACITY USER as a result of the reduction or curtailment in its SERVICES ENTITLEMENT.

4.3 **Suspension of Service**

OPERATOR may, for the duration of any ADVERSE WEATHER CONDITIONS, temporarily suspend affected operations at the RECEIVING FACILITY, where in OPERATOR'S sole opinion, it is necessary to do so for safety reasons related to the ADVERSE WEATHER CONDITIONS. OPERATOR shall notify CAPACITY USER of such suspension as soon as reasonably practicable in accordance with AA 25.0.

4.4 **SECURITY OF SUPPLY**

In the event of a national security of supply crisis and a government directive relating to the security of gas supply to Peninsular Malaysia is issued in relation to, the PARTIES acknowledge and agree that such government directive, to the extent that it affects the RECEIVING FACILITY and is inconsistent with the TERMINAL USE AGREEMENT, shall prevail over the terms of the TERMINAL USE AGREEMENT.

5.0 **FEES**

5.1 In consideration of the SERVICES rendered by OPERATOR to CAPACITY USER, and subject to the other provisions of this ACCESS ARRANGEMENT, CAPACITY USER shall pay the sum of the components below:

- (a) the REGASIFICATION FEE;
- (b) the INTERRUPTIBLE REGASIFICATION FEE;

(c) the STORAGE FEE; and

(d) the RELOAD FEE,

(such amount collectively referred to as the "FEE").

5.2 The REGASIFICATION FEE for each CONTRACT MONTH shall be calculated as follows:

$A \times B \times C$

where

A = the REGASIFICATION TARIFF expressed on a per MMBTU basis be denominated in USD (United States Dollars) and converted into MMBTU in accordance with Schedule 14), as determined and published by OPERATOR from time to time in accordance with the TPA CODE.

B = the number of GAS DAYS in the CONTRACT MONTH; and

C = REGASIFICATION SERVICES ENTITLEMENT (in MMBTU per day).

5.3 The INTERRUPTIBLE REGASIFICATION FEE for each CONTRACT MONTH shall be calculated as follows:

$A \times B$

where

A = the INTERRUPTIBLE REGASIFICATION TARIFF expressed on a per MMBTU basis (which shall be denominated in USD (United States Dollars) and converted into MMBTU in accordance with Schedule 14), as determined and published by OPERATOR from time to time in accordance with the TPA CODE;

B = the quantities of SEND OUT GAS delivered to, or on behalf of, CAPACITY USER in excess of its MAXIMUM SEND OUT RATE for any GAS DAY during the CONTRACT MONTH.

5.4 If relevant, the calculation of the RELOAD FEE and the STORAGE FEE for each CONTRACT MONTH shall be set out in the SPECIFIC TERMS AND CONDITIONS.

5.5 OPERATOR shall promptly notify CAPACITY USER on any changes of the published REGASIFICATION TARIFF, INTERRUPTIBLE REGASIFICATION TARIFF, the STORAGE TARIFF or the RELOAD TARIFF.

5.6 CAPACITY USER shall not pay the FEE (excluding the INTERRUPTIBLE REGASIFICATION FEE) for any GAS DAYS during which the RECEIVING FACILITY is UNAVAILABLE due to OPERATOR's fault (and any reduction in the FEE as a result of the RECEIVING FACILITY being UNAVAILABLE for less than a whole GAS DAY shall be calculated on a pro rata basis to the nearest hour).

6.0 LNG VESSELS

6.1 LNG VESSELS' Specification

- (a) CAPACITY USER shall ensure that, subject to any deviations agreed in writing with OPERATOR, only LNG VESSELS which have been approved by OPERATOR in accordance with the TERMINAL INFORMATION BOOKLET as meeting the LNG VESSELS SPECIFICATIONS and being in all respects compatible with the RECEIVING FACILITY.
- (b) CAPACITY USER shall ensure that each of the LNG VESSELS must:
 - (i) be operated and maintained in good working order in accordance with all APPLICABLE LAWS, AUTHORISATIONS, INTERNATIONAL LNG VESSEL STANDARDS and, to the extent not inconsistent with the foregoing, such good and prudent practices as are generally followed in the LNG industry by REASONABLE AND PRUDENT OPERATORS of LNG carriers;
 - (ii) be managed by a reputable ship manager;
 - (iii) be operated and maintained by:
 - (A) a competent and reputable vessel operator;
 - (B) officers and crew who have the ability, experience, licences and training commensurate with the performance of their duties in accordance with INTERNATIONAL LNG VESSEL STANDARDS and as required by any GOVERNMENTAL AUTHORITY and any labour organisation having jurisdiction over the LNG VESSEL or its crew;
 - (C) cargo officers and other officers, who may reasonably need to communicate with OPERATOR, who speak English;
 - (D) a master who has been trained and certified to a standard customary for an operator of a first-class LNG vessel of the type and tonnage of the LNG VESSEL and who is fluent in written and oral English ("MASTER");
 - (E) a chief engineer, chief mate and cargo engineer (and such other officers of the LNG VESSEL having responsibilities associated with the preparation of the LNG VESSEL for unloading) who have been trained and certified to a standard customary for an operator of a first-class LNG vessel of the type and tonnage of the LNG VESSEL and who are fluent in written and oral English; and
 - (F) shipboard personnel who hold valid certificates of competence in accordance with the requirements of the law of the flag state of the LNG VESSEL and APPLICABLE LAWS and AUTHORISATIONS;

- (iv) be inspected by a SIRE ACCREDITED INSPECTOR, pursuant to AA 6.3; and
- (v) be inspected by MMS pursuant to AA 6.3 and in accordance with the TERMINAL INFORMATION BOOKLET.

6.2 **Compatibility and Inspections**

CAPACITY USER shall ensure that, subject to any deviations agreed in writing with OPERATOR, only LNG VESSELS which have been approved by OPERATOR in accordance with the TERMINAL INFORMATION BOOKLET as meeting the LNG VESSELS SPECIFICATIONS and being in all respects compatible with the RECEIVING FACILITY call at the RECEIVING FACILITY.

- (a) CAPACITY USER shall ensure that:
 - (i) its LNG VESSELS are fully compatible with the RECEIVING FACILITY; and
 - (ii) its LNG VESSELS are capable of:
 - (A) navigating and manoeuvring within the Pengerang Deepwater Terminal; and
 - (B) reaching the RECEIVING FACILITY, discharging LNG, reloading LNG and departing the RECEIVING FACILITY,

in all cases in accordance with all APPLICABLE LAWS and AUTHORISATIONS.
- (b) OPERATOR shall provide reasonable assistance to CAPACITY USER in carrying out the due diligence necessary to comply with AA 6.2(a) above.
- (c) CAPACITY USER shall provide OPERATOR with sufficient details of its LNG VESSELS to allow OPERATOR or an appointed third party by the CAPACITY USER to conduct a compatibility study between the RECEIVING FACILITY and each LNG VESSEL so as to allow OPERATOR to verify the compatibility of each LNG VESSEL with the RECEIVING FACILITY and each LNG VESSEL's compliance with all INTERNATIONAL LNG VESSEL STANDARDS, APPLICABLE LAWS and AUTHORISATIONS. OPERATOR shall inform CAPACITY USER of the results of the review of all information provided pursuant to this AA 6.2(c) as soon as reasonably practicable in writing and shall provide the spreadsheet of ship shore compatibility requirements.
- (d) OPERATOR shall, with the consent of the LNG VESSEL's MASTER (such consent not to be unreasonably withheld or delayed), have the right to board any LNG VESSEL whilst it is at berth at the RECEIVING FACILITY for the sole purpose of conducting an inspection of the LNG VESSEL in the presence of a designated crew member escort. OPERATOR will inform the MASTER of the LNG VESSEL of the results of the inspection.

- (e) A list of remarks and/or irregularities arising from the inspection conducted in accordance with AA 6.2(d) if any, shall be immediately provided to the MASTER at the conclusion of the inspection. The list of the remarks and irregularities shall also be provided to CAPACITY USER and/or all relevant parties. To the extent any such inspection reveals (in the reasonable opinion of OPERATOR) any failure by an LNG VESSEL to comply with the terms of this ACCESS ARRANGEMENT, such LNG VESSEL shall cease to be an approved LNG VESSEL until such time as the failure to comply with the terms of this ACCESS ARRANGEMENT is remedied. CAPACITY USER shall provide an implementation schedule, which shall be in form and substance acceptable to OPERATOR, of the corrective actions and such certificates from the LNG VESSEL operator of such LNG VESSEL as OPERATOR may reasonably require to verify that the identified failure by an LNG VESSEL to comply with the terms of this ACCESS ARRANGEMENT has been remedied prior to the restoration of such LNG VESSEL's status as an approved LNG VESSEL.
- (f) No inspection (or lack thereof) or approval of the LNG VESSEL by OPERATOR, or any requests or observations made to CAPACITY USER or its representatives by or on behalf of OPERATOR in connection with any such inspection or approval, shall of itself:
 - (i) modify or amend CAPACITY USER'S obligations, representations, warranties and covenants under this ACCESS ARRANGEMENT; or
 - (ii) constitute an acceptance or waiver by OPERATOR of CAPACITY USER'S obligations under this ACCESS ARRANGEMENT.
- (g) Once OPERATOR is satisfied that the LNG VESSEL is compatible with the RECEIVING FACILITY, the nominated LNG VESSEL shall be deemed approved by issuance of Certificate of Acceptance and can be nominated in the issued ANNUAL OPERATION SCHEDULE in accordance with this ACCESS ARRANGEMENT.

6.3 LNG VESSEL Inspection

- (a) Each LNG VESSEL nominated by CAPACITY USER for use at the RECEIVING FACILITY shall, at CAPACITY USER'S cost and expense, be inspected and reported upon by a SIRE ACCREDITED INSPECTOR and MMS.
- (b) CAPACITY USER acknowledges that each report issued by a SIRE ACCREDITED INSPECTOR and MMS for each LNG VESSEL shall have a validity period and CAPACITY USER shall ensure that a report issued in respect of an LNG VESSEL nominated by CAPACITY USER shall be valid for the period during which such LNG VESSEL is berthed at the RECEIVING FACILITY. In the case of a report issued by a SIRE ACCREDITED INSPECTOR, the validity period shall be as determined pursuant to Schedule 1. In the case of a report issued by MMS, the validity period shall be determined pursuant to the Terminal Information Booklet.
- (c) If there are any material deficiencies noted in the inspection reports in respect of an LNG VESSEL made pursuant to AA 6.3(a), OPERATOR may by written

notice to CAPACITY USER determine that such LNG VESSEL shall cease to be an approved LNG VESSEL until the material deficiencies have been remedied to OPERATOR'S reasonable satisfaction.

6.4 LNG VESSELS' non-compliance to LNG VESSELS SPECIFICATION AFTER LNG VESSEL APPROVAL

- (a) OPERATOR is under no obligation to accept, and may reject, delivery of LNG from an LNG VESSEL that does not meet the requirements of this AA 6.0.
- (b) OPERATOR shall not be in breach of its obligations under this ACCESS ARRANGEMENT to the extent that a breach would, but for this provision, arise as a result of or in connection with the fact that the LNG VESSEL does not meet the LNG VESSELS SPECIFICATION.
- (c) CAPACITY USER shall protect, indemnify, defend and hold harmless OPERATOR for and against any direct costs, losses and expenses reasonably incurred by OPERATOR arising as a result of berthing, servicing, discharging and reloading LNG from and/or preparing for departure any LNG VESSEL that does not meet the requirements of this AA 6.0 that OPERATOR would not have incurred had the LNG VESSEL met the requirements of this AA 6.0.

6.5 Authorisations

CAPACITY USER shall promptly:

- (a) obtain, comply with and do or cause to obtain, comply and do all that is necessary to maintain in full force; and
- (b) once obtained, supply a certified copy to OPERATOR of,

any AUTHORISATIONS required under any APPLICABLE LAWS or any INTERNATIONAL LNG VESSEL STANDARDS to enable CAPACITY USER (or its nominated authorised representative) to:

- (i) charter each of the LNG VESSELS;
- (ii) navigate the LNG VESSELS in the territorial waters of Malaysia;
- (iii) berth the LNG VESSELS at the RECEIVING FACILITY;
- (iv) discharge LNG from the LNG VESSELS at the LNG RECEIPT POINT;
- (v) if CAPACITY USER has a RELOAD SERVICES ENTITLEMENT, reload LNG into the LNG VESSELS at the LNG RELOAD DELIVERY POINT; and
- (vi) otherwise perform its obligations in relation to the LNG VESSELS under this ACCESS ARRANGEMENT.

7.0 NOMINATIONS AND SCHEDULING

7.1 ANNUAL NOMINATION SCHEDULE

Open

Not later than four (4) months before the commencement of each CONTRACT YEAR, each CAPACITY USER will give OPERATOR a proposed nomination schedule based on an assumed standard conversion factor calculated pursuant to Schedule 14 for:

- (a) delivery and/or reloading of the CARGOES that CAPACITY USER proposes to be unloaded and/or reloaded at the RECEIVING FACILITY over the 12 month period commencing on the first day of the next CONTRACT YEAR (an "ANNUAL NOMINATION SCHEDULE"). In its proposed ANNUAL NOMINATION SCHEDULE, CAPACITY USER shall:
 - (i) nominate a schedule for the delivery and/or reloading of CARGOES and the corresponding BERTHING SLOTS:
 - (A) to achieve as regular and even rates and intervals of deliveries and/or reload of CARGOES to the RECEIVING FACILITY as practicable (having regard to the relevant CARGO sizes) over the 12 month period commencing on the first day of the next CONTRACT YEAR;
 - (B) that takes into account CAPACITY USER'S MAXIMUM ALLOWED BERTHING SLOTS;
 - (C) that does not result in CAPACITY USER exceeding its STORAGE SERVICES ENTITLEMENT at any time, based on an indicative good faith estimate of such CAPACITY USER'S SEND OUT GAS redelivery and/or reload profiles for the CONTRACT YEAR; and
 - (D) that reduces CAPACITY USER'S LNG inventory to zero (0) by the end of the TERM;
 - (ii) take into account any applicable restrictions contained or referred to in the TERMINAL INFORMATION BOOKLET and regulations applicable in the PENGERANG DEEPWATER TERMINAL;
 - (iii) take into account any relevant planned construction, repair and/or maintenance on the PGU NETWORK;
 - (iv) only nominate LNG VESSELS that comply, or will comply at the time of delivery or reloading of the relevant CARGO, with the LNG VESSELS SPECIFICATIONS, the TERMINAL USE AGREEMENT and the regulations applicable in the PENGERANG DEEPWATER TERMINAL;
 - (v) only nominate CARGOES of quantities that CAPACITY USER reasonably expects to deliver or reload at the RECEIVING FACILITY;
 - (vi) not schedule the delivery of CARGOES to the extent that the aggregate of such deliveries would cause the resulting NATURAL GAS and any reloaded LNG to exceed the ACQ for such CONTRACT YEAR (as adjusted pursuant to AA 7.3); and
 - (vii) not schedule a delivery that would then conflict with periods of unavailability of facilities at the RECEIVING FACILITY indicated by the

then current ANNUAL MAINTENANCE PROGRAMME, provided that, notwithstanding the foregoing, CAPACITY USER may request that OPERATOR reschedule projected periods of unavailability of facilities at the RECEIVING FACILITY as set forth in the current ANNUAL MAINTENANCE PROGRAMME; and

- (b) its indicative good faith estimate of such CAPACITY USER'S SEND OUT GAS redelivery and/or reload profiles for the CONTRACT YEAR which shall comply with CAPACITY USER'S MAXIMUM SEND OUT RATE and MINIMUM SEND OUT RATE.

7.2 CAPACITY USER'S number of requested BERTHING SLOTS;

- (a) An ANNUAL NOMINATION SCHEDULE may include a request by CAPACITY USER for BERTHING SLOTS in a CONTRACT YEAR in excess of its MAXIMUM ALLOWED BERTHING SLOTS, provided that such additional BERTHING SLOTS are necessary for CAPACITY USER to deliver its ACQ for the CONTRACT YEAR. CAPACITY USER acknowledges that if its ANNUAL NOMINATION SCHEDULE does not include a request for the full quantity of BERTHING SLOTS up to its MAXIMUM ANNUAL BERTHING SLOTS then, as a result of other allocations of BERTHING SLOTS by OPERATOR, it may not subsequently be possible for CAPACITY USER to obtain its full quantity of BERTHING SLOTS up to its MAXIMUM ANNUAL BERTHING SLOTS in the relevant CONTRACT YEAR.
- (b) The ANNUAL NOMINATION SCHEDULE shall specify for each CARGO the proposed SCHEDULED DATE OF ARRIVAL, the name of the LNG VESSEL (if the identity of the LNG VESSEL is known to CAPACITY USER at such time) and the quantity expected to be unloaded or reloaded.

7.3 Rounding of ACQs

If in respect of any CONTRACT YEAR CAPACITY USER anticipates that, solely as a result of the CARGO sizes that CAPACITY USER proposes to deliver to and/or reload at RECEIVING FACILITY, the NATURAL GAS and/or LNG to be delivered and/or reloaded by OPERATOR to CAPACITY USER will be less than or will exceed such CAPACITY USER'S ACQ, CAPACITY USER may request in its ANNUAL NOMINATION SCHEDULE that:

- (a) the shortfall relative to the ACQ shall be carried forward and added to the ACQ for the following CONTRACT YEAR; or
- (b) the excess over the ACQ shall be carried forward and deducted from the ACQ for the following CONTRACT YEAR,

in each case subject to the provision that the ACQ as adjusted pursuant to AA 7.3(a) and (b) above shall not exceed or be less than CAPACITY USER'S BASE ACQ by a quantity greater than the NATURAL GAS resulting from the regasification of a CARGO of 145,000 m³ of LNG. For this purpose "BASE ACQ" means CAPACITY USER'S ACQ. OPERATOR shall use its REASONABLE ENDEAVOURS to accept all such requests from CAPACITY USER and other CAPACITY USERS and, if so accepted,

the ACQ of CAPACITY USER and other CAPACITY USERS will be adjusted accordingly for the relevant CONTRACT YEARS.

7.4 OPERATOR to provide PRELIMINARY ANNUAL OPERATION SCHEDULE

- (a) OPERATOR will by no later than 15 September of each CONTRACT YEAR, publish on the ELECTRONIC COMMUNICATION SYSTEM the details of CAPACITY USERS' ANNUAL NOMINATION SCHEDULES ("PRELIMINARY ANNUAL OPERATION SCHEDULE) comprising:
 - (i) the BERTHING SLOTS for the unloading or reloading of each CAPACITY USER'S CARGOES (together with the relevant CARGO sizes) for the 12 month period commencing on the first day of the next CONTRACT YEAR provided that each CAPACITY USER shall only be able to view which BERTHING SLOTS have been allocated for delivery and/or reloading of its CARGOES and which BERTHING SLOTS are not scheduled to be utilised;
 - (ii) for each CAPACITY USER and each GAS DAY, the CAPACITY USER'S AVAILABLE INVENTORY and BORROWING; and
 - (iii) the draft BORROWING AND LENDING SCHEDULE.
- (b) In preparing the PRELIMINARY ANNUAL OPERATION SCHEDULE, OPERATOR shall:
 - (i) accommodate any CAPACITY USER'S requests for additional BERTHING SLOTS made in accordance with AA 7.2(a) to the extent that they do not cause any scheduling conflicts and the additional BERTHING SLOTS are necessary to deliver CAPACITY USER'S ACQ for the relevant CONTRACT YEAR. There shall be no additional charge for such additional BERTHING SLOTS;
 - (ii) clearly identify and explain each scheduling conflict (such as a conflict with the ANNUAL MAINTENANCE PROGRAMME, or a conflict between requests for a particular BERTHING SLOT by more than one CAPACITY USER which would result from the acceptance by OPERATOR of any BERTHING SLOT requested by CAPACITY USER in an ANNUAL NOMINATION SCHEDULE); and
 - (iii) use REASONABLE ENDEAVOURS to reschedule periods of unavailability of facilities at the RECEIVING FACILITY as then set forth in the then current ANNUAL MAINTENANCE PROGRAMME that would result in any scheduling conflicts, provided that, if rescheduling would require OPERATOR to incur additional cost, OPERATOR shall provide the relevant CAPACITY USER with a good faith estimate of such costs, and OPERATOR will reschedule the relevant periods of facility unavailability if and only if that CAPACITY USER agrees to pay the actual costs resulting from such rescheduling.

7.5 Resolution of scheduling conflicts

- (a) If the PRELIMINARY ANNUAL OPERATION SCHEDULE shows any scheduling conflicts then, by no later than fifteen (15) days following the publication of the PRELIMINARY ANNUAL OPERATION SCHEDULE, OPERATOR shall convene a meeting of CAPACITY USERS and OPERATOR to resolve those scheduling conflicts. Any resolution of those scheduling conflicts must be consistent with the principles set forth in AA 7.1, with the exception of AA 7.1(a)(i)(A).

- (b) If CAPACITY USERS are unable to resolve the scheduling conflicts by 15 October in the relevant year, then OPERATOR shall resolve them in a manner consistent with any specific guidance provided by CAPACITY USERS which is consistent with the principles in AA 7.1, with the exception of AA 7.1(a)(i)(A) (it being agreed that OPERATOR may reject any such guidance that does not comply with such principles and, in the absence of any such guidance, OPERATOR shall give priority to CAPACITY USER with the largest ACQ, and if there is more than one CAPACITY USER with the largest ACQ, OPERATOR shall give priority to CAPACITY USER which has the largest ACQ and was the first to enter into its TERMINAL USE AGREEMENT provided that OPERATOR shall use REASONABLE ENDEAVOURS to:
 - (i) maximize the aggregate number of BERTHING SLOTS;
 - (ii) schedule the delivery and/or reload of CARGOES:
 - (A) to grant each CAPACITY USER at least the number of BERTHING SLOTS requested up to each CAPACITY USER'S MAXIMUM ALLOWED BERTHING SLOTS pursuant to the TERMINAL USE AGREEMENT;
 - (B) to reflect CAPACITY USERS' ANNUAL NOMINATION SCHEDULES to the maximum extent practicable, except to the extent that those schedules did not satisfy the principles set forth in AA 7.1;
 - (C) to achieve as regular and even rates and intervals of deliveries and reload of CARGOES as practicable (having regard to the relevant CARGO sizes) over the next CONTRACT YEAR;
 - (D) to ensure that no CAPACITY USER exceeds its STORAGE SERVICES ENTITLEMENT at any time, based on the indicative good faith estimate of such CAPACITY USER'S SEND OUT GAS redelivery and reload profile for the CONTRACT YEAR referred to in AA 7.1(b);
 - (E) assuming that delivery of NATURAL GAS does not exceed the MAXIMUM SEND OUT RATE for each CAPACITY USER; and
 - (F) to ensure that OPERATOR maintains the MINIMUM HEEL REQUIREMENT at all times;
 - (iii) take into account the applicable restrictions contained in the Unloading Port Regulations;

- (iv) take into account any relevant planned construction, repair and/or maintenance on the PGU NETWORK;
- (v) not schedule the delivery of CARGOES to the extent that the aggregate of such deliveries would cause the resulting NATURAL GAS and/or LNG to exceed that CAPACITY USER'S ACQ for such CONTRACT YEAR;
- (vi) use REASONABLE ENDEAVOURS to reschedule periods of unavailability of facilities at the RECEIVING FACILITY as then set forth in the then current ANNUAL MAINTENANCE PROGRAMME that would result in any scheduling conflicts; provided that if rescheduling would require OPERATOR to incur additional cost, OPERATOR shall provide the relevant CAPACITY USER with a good faith estimate of such costs, and OPERATOR will reschedule the relevant periods of facility unavailability if and only if that CAPACITY USER agrees to pay the actual costs resulting from such rescheduling;
- (vii) grant requests for additional BERTHING SLOTS (at no charge), provided that:
 - (A) such additional BERTHING SLOTS are necessary for CAPACITY USER to deliver its ACQ for the relevant CONTRACT YEAR; and
 - (B) their inclusion would not cause material changes to the schedule that would have been adopted but for their inclusion,

and to the extent there are insufficient additional BERTHING SLOTS to accommodate all such requests, then allocate such additional BERTHING SLOTS to CAPACITY USERS that requested such additional BERTHING SLOTS pro rata to their respective ACQs; and
- (viii) allow replacement BERTHING SLOTS only if their inclusion would not cause material changes to the schedule that would have been adopted but for their inclusion.

7.6 Annual Operation Schedule

- (a) By no later than thirty (30) days prior to each CONTRACT YEAR, OPERATOR will publish on the ELECTRONIC COMMUNICATION SYSTEM the details of the ANNUAL OPERATION SCHEDULE ("ANNUAL OPERATION SCHEDULE") comprising:
 - (i) the BERTHING SLOTS for the unloading or reloading of each CAPACITY USER'S CARGOES (together with the relevant CARGO SIZES) for the 12 month period commencing on the first day of the next CONTRACT YEAR provided that each CAPACITY USER shall only be able to view which BERTHING SLOTS have been allocated for delivery and/or reloading of its CARGOES and which BERTHING SLOTS are not scheduled to be utilised;
 - (ii) for each CAPACITY USER and each GAS DAY, the CAPACITY USER'S AVAILABLE INVENTORY and BORROWING; and

- (iii) the BORROWING AND LENDING SCHEDULE.
- (b) The ANNUAL OPERATION SCHEDULE shall be, as appropriate, the PRELIMINARY ANNUAL OPERATION SCHEDULE if there are no conflicts, or the schedule as negotiated by the CAPACITY USERS pursuant to AA 7.4(a), or the schedule set by OPERATOR pursuant to AA 7.4(b).

7.7 Draft Three Month Schedules

- (a) By no later than the twentieth (20) day of each CONTRACT MONTH, CAPACITY USER will give OPERATOR a proposed nomination schedule (THREE MONTH NOMINATION SCHEDULE) specifying:
 - (i) the BERTHING SLOTS for the delivery of CARGOES to be unloaded or reloaded at the RECEIVING FACILITY (together with the relevant CARGO sizes) for the three (3) CONTRACT MONTHS commencing on the first (1st) day of the next CONTRACT MONTH; and
 - (ii) the nomination and forecast to be provided pursuant to AA 7.11.
- (b) Each THREE MONTH NOMINATION SCHEDULE must be consistent with the then current ANNUAL OPERATION SCHEDULE as far as practicable. Any proposed changes (other than in respect of the BORROWING AND LENDING SCHEDULE) must comply with the principles set forth in AA 7.1 subject to any explicit confirmation by all CAPACITY USERS that they wish to deviate from the principle stated in AA 7.1(a)(i)(A). Furthermore, consistent with AA 7.1(a)(vii), CAPACITY USER may request that OPERATOR reschedule periods of unavailability of facilities at the Terminal as set forth in the then current ANNUAL MAINTENANCE PROGRAMME.

7.8 Three Month Schedules

- (a) By no later than the twenty second (22nd) day of each month during the TERM, OPERATOR will publish on the ELECTRONIC COMMUNICATION SYSTEM a draft schedule including each CAPACITY USER'S THREE MONTH NOMINATION SCHEDULE and specifying for the three (3) CONTRACT MONTH period commencing on the first (1st) day of the next CONTRACT MONTH :
 - (i) the BERTHING SLOTS for the unloading or reloading of each CAPACITY USER'S CARGOES (together with the relevant CARGO sizes) to be unloaded or reloaded at the RECEIVING FACILITY provided that each CAPACITY USER shall only be able to view which BERTHING SLOTS have been allocated for delivery and/or reloading of its CARGOES and which BERTHING SLOTS are not scheduled to be utilised; and
 - (ii) for each CAPACITY USER and each GAS DAY, that CAPACITY USER'S AVAILABLE INVENTORY and BORROWING LIMIT;
 - (iii) including the BORROWING AND LENDING SCHEDULE.

- (b) The THREE MONTH SCHEDULE shall be binding and firm for the first CONTRACT MONTH and provisional for the second and third CONTRACT MONTHS.
- (c) If the draft schedule shows no:
 - (i) scheduling conflicts (such as conflicts with the ANNUAL MAINTENANCE PROGRAMME); or
 - (ii) requests for a BERTHING SLOT already assigned to another CAPACITY USER; or
 - (iii) conflicting requests for an unclaimed BERTHING SLOT; or
 - (iv) requirement for any CAPACITY USER to suffer a reallocation of any of its STORAGE SERVICES ENTITLEMENT to a greater extent than already anticipated by the then current ANNUAL OPERATION SCHEDULE,

then that schedule will be the THREE MONTH OPERATION SCHEDULE and will amend the ANNUAL OPERATION SCHEDULE .

- (d) If the draft schedule shows a scheduling conflict of any type set out in AA 7.8(c), then OPERATOR will clearly identify such conflict, with an explanation of the conflict and, by no later than the twenty fifth (25th) day of that month, OPERATOR shall convene a meeting of CAPACITY USERS to resolve those scheduling conflicts. Any resolution of those scheduling conflicts must be consistent with the principles set forth in AA 7.1 subject to any explicit confirmation by all CAPACITY USERS that they wish to deviate from the principle stated in AA 7.1(a)(i)(A) (it being agreed that OPERATOR may reject any such resolution that does not comply with such principles). Furthermore, OPERATOR shall use REASONABLE ENDEAVOURS to reschedule periods of unavailability of facilities at the RECEIVING FACILITY as then set forth in the then current ANNUAL MAINTENANCE PROGRAMME that would result in any scheduling conflicts; provided that, if rescheduling would require OPERATOR to incur additional cost, OPERATOR shall provide the relevant CAPACITY USER with a good faith estimate of such costs, and OPERATOR will reschedule the periods of unavailability if and only if that CAPACITY USER agrees to pay the actual costs resulting from such rescheduling. Subject to the requirements of this AA 7.8(d), the agreed schedule will be the THREE MONTH OPERATION SCHEDULE and will be published on the ELECTRONIC COMMUNICATION SYSTEM by OPERATOR as soon as reasonably practicable and in any event no later than the twenty seventh (27th) day of that month.
- (e) If CAPACITY USERS are unable to resolve the scheduling conflicts or the agreed schedule is not compliant with the principles in AA 7.1 (subject to any explicit confirmation by all CAPACITY USERS that they wish to deviate from the principle stated in AA 7.1(a)(i)(A)), then the THREE MONTH OPERATION SCHEDULE (to be published by OPERATOR no later than the twenty seventh (27th) day of that month) shall reflect the then existing ANNUAL OPERATION SCHEDULE.

7.9 CAPACITY USER changes to ANNUAL OPERATION SCHEDULE or THREE MONTH OPERATION SCHEDULE

- (a) CAPACITY USER (including, for the avoidance of doubt, a SHORT TERM CAPACITY USER who has subscribed for capacity pursuant to AA 3.2 and AA 3.3 after the issue of the ANNUAL OPERATION SCHEDULE) may at any time request changes to an ANNUAL OPERATION SCHEDULE or THREE MONTH OPERATION SCHEDULE (including requests for additional BERTHING SLOTS) by providing OPERATOR with the details of such proposed changes.
- (b) OPERATOR will:
 - (i) consider requests by CAPACITY USERS to change an ANNUAL OPERATION SCHEDULE or THREE MONTH OPERATION SCHEDULE on a first-come, first-served basis;
 - (ii) consult with the other CAPACITY USERS;
 - (iii) not accept any proposed change without the consent of any CAPACITY USER who is adversely affected by the proposed change;
 - (iv) use REASONABLE ENDEAVOURS to reschedule periods of unavailability of facilities at the RECEIVING FACILITY as then set forth in the then current ANNUAL MAINTENANCE PROGRAMME that would result in any scheduling conflicts; provided that, if rescheduling would require OPERATOR to incur additional cost, OPERATOR shall provide the relevant CAPACITY USER with a good faith estimate of such costs, and OPERATOR will reschedule the relevant periods of facility unavailability if and only if that CAPACITY USER agrees to pay the actual costs resulting from such rescheduling; and
 - (v) accept or reject the request and/or any proposed alternative change consistent with the principles set forth in AA 7.1, subject to any confirmation by the affected CAPACITY USERS that they wish to deviate from the principle stated in AA 7.1(a)(i)(A), and subject to AA 7.9(c).

If OPERATOR approves the requested change, then as soon as reasonably practicable it will publish a revised ANNUAL OPERATION SCHEDULE or THREE MONTH OPERATION SCHEDULE (or details of the applicable revisions) on the ELECTRONIC COMMUNICATION SYSTEM.

- (c) OPERATOR shall not unreasonably withhold its consent to requested changes to the ANNUAL OPERATION SCHEDULE or THREE MONTH OPERATION SCHEDULE, provided that OPERATOR shall not be required to accommodate any such requested change if:
 - (i) it would have an adverse effect on the safe and reliable use of the RECEIVING FACILITY in accordance with the standards of a REASONABLE AND PRUDENT OPERATOR; or

- (ii) It would have an adverse effect on OPERATOR'S ability to comply with its obligations to CAPACITY USERS or subject to OPERATOR to a material risk of liability for the cancellation of a BERTHING SLOT.

7.10 OPERATOR changes to ANNUAL OPERATION SCHEDULE or THREE MONTH OPERATION SCHEDULE

- (a) OPERATOR may revise an ANNUAL OPERATION SCHEDULE or THREE MONTH OPERATION SCHEDULE of its own initiative only:
 - (i) to reflect the BERTHING SLOTS and relevant details attributable to SHORT TERM CAPACITY USERS who have subscribed for capacity pursuant to AA 3.2 and AA 3.3; or
 - (ii) after consultation with all CAPACITY USERS affected by the revision, if the JOHOR PORT AUTHORITY changes the available times for LNG VESSELS to enter and leave the PENDERANG DEEPWATER TERMINAL; or
 - (iii) with the consent of each CAPACITY USER to whom a BERTHING SLOT is allocated for which the SCHEDULED DATE OF ARRIVAL could be affected by the revision (such consent not to be unreasonably withheld or delayed); or
 - (iv) to reflect the cancellation by a CAPACITY USER of the CAPACITY USER'S scheduled delivery or deliveries (or reload or reloads) of CARGOES; or
 - (v) after consultation with all CAPACITY USERS affected by the revision, in any case where an EVENT OF FORCE MAJEURE affecting OPERATOR will prevent it from complying with its obligations to berth and unload or reload LNG VESSELS in accordance with the ANNUAL OPERATION SCHEDULE or THREE MONTH OPERATION SCHEDULE.
- (b) OPERATOR will publish a revised ANNUAL OPERATION SCHEDULE or THREE MONTH OPERATION SCHEDULE (or details of the applicable revisions) on the ELECTRONIC COMMUNICATIONS SYSTEM as soon as reasonably practicable.
- (c) Where a change to an ANNUAL OPERATION SCHEDULE or THREE MONTH OPERATION SCHEDULE has been requested by OPERATOR or any CAPACITY USER, OPERATOR and CAPACITY USER agree to extend reasonable co-operation in respect of such requested changes to ensure smooth LNG VESSEL operations in relation to the RECEIVING FACILITY.

7.11 SEND OUT GAS NOMINATION

- (a) By no later than the twentieth (20th) day of each CONTRACT MONTH (M), CAPACITY USER shall provide, as part of CAPACITY USER'S THREE MONTH NOMINATION SCHEDULE which is to be submitted pursuant to AA 7.7(a):

- (i) a nomination to OPERATOR in respect of the daily quantity of NATURAL GAS required to be redelivered to CAPACITY USER on each GAS DAY over the immediately following CONTRACT MONTH (M+1) ("SCHEDULED MONTH") (the "SCHEDULED DAILY GAS QUANTITY") (and the sum of SCHEDULED DAILY GAS QUANTITIES shall be the "SCHEDULED MONTHLY GAS QUANTITY" for such SCHEDULED MONTH);
 - (ii) a non-binding good faith forecast to OPERATOR in respect of the daily quantity of NATURAL GAS required to be redelivered to CAPACITY USER on each GAS DAY over the second and third succeeding CONTRACT MONTHS (M+2 and M+3); and
 - (iii) any INTERRUPTIBLE REGASIFICATION SERVICE which CAPACITY USER wishes to receive on any GAS DAY.
- (b) The "SCHEDULED DAILY GAS QUANTITY" for each GAS DAY shall be a quantity which is between CAPACITY USER'S MAXIMUM SEND OUT RATE and its MINIMUM SEND OUT RATE for that GAS DAY in such SCHEDULED MONTH. If CAPACITY USER fails to provide such nominations, its SCHEDULED DAILY GAS QUANTITY shall be deemed to be in accordance with the THREE MONTH NOMINATION SCHEDULE.
- (c) Subject to AA 7.11(e), CAPACITY USER shall on or before 1200 hours of each GAS DAY, nominate a specified quantity of SEND OUT GAS in MMBTU per day for delivery to the NATURAL GAS DELIVERY POINT in the following seven (7) GAS DAYS ("DAILY SEND OUT GAS NOMINATION") by submitting its daily nomination to OPERATOR. Further details regarding the nomination procedure are set out in Schedule 8. The DAILY SEND OUT GAS NOMINATION shall be binding and firm for the first GAS DAY (unless amended in accordance with AA 7.11(d)) and provisional for the subsequent six (6) GAS DAYS.
- (d) Subject to AA 7.11(e), CAPACITY USER may at any time until fourteen (14) hours prior to the start of any GAS DAY, revise DAILY SEND OUT GAS NOMINATION for that GAS DAY by submitting a re-nomination in accordance with Schedule 8 and the principles in this AA 7.11. Any revised nomination submitted by CAPACITY USER less than fourteen (14) hours prior to the start of any GAS DAY shall be on a REASONABLE ENDEAVOURS basis and shall only supersede the previous DAILY SEND OUT GAS NOMINATION if accepted by OPERATOR.
- (e) Subject to the provisions of the INTER-CAPACITY USER AGREEMENT, CAPACITY USER may only nominate a quantity of SEND OUT GAS for delivery:
- (i) that is not more than the quantity of LNG which CAPACITY USER has or will have stored in the LNG STORAGE TANK; and
 - (ii) at a rate of delivery that is not less than the MINIMUM SEND OUT RATE.

- (f) OPERATOR shall review all DAILY SEND OUT GAS NOMINATIONS and other nominations submitted by CAPACITY USERS.
- (g) For each GAS DAY, and subsequently with respect to each revision of a CAPACITY USER'S DAILY SEND OUT GAS NOMINATION for such GAS DAY, OPERATOR shall allocate the TOTAL REGASIFICATION CAPACITY (which for the purposes of this AA 7.11(g), shall be deemed to exclude any reduction in SERVICES allocated in accordance with AA 4.2(a), if applicable) as follows:
 - (i) OPERATOR shall allocate to each REGASIFICATION CAPACITY USER (excluding any SHORT TERM CAPACITY USER) an amount of regasification capacity equal to the lesser of (A) each such REGASIFICATION CAPACITY USER'S DAILY SEND OUT GAS NOMINATION, and (B) such REGASIFICATION CAPACITY USER'S MAXIMUM SEND OUT RATE;
 - (ii) Any remaining capacity not allocated pursuant to AA 7.11(g)(i) shall be allocated to each REGASIFICATION CAPACITY USER (which is also a SHORT TERM CAPACITY USER) on a first come, first served basis, provided that no REGASIFICATION CAPACITY USER shall be allocated, pursuant to AA 7.11(g)(ii), in respect of any GAS DAY, an amount of regasification capacity greater than the daily equivalent of the ANNUAL CONTRACT QUANTITY for that CONTRACT YEAR;
 - (iii) Any remaining capacity not allocated pursuant to AA 7.11(g)(i) and AA 7.11(g)(ii) shall be made available to all REGASIFICATION CAPACITY USERS as "INTERRUPTIBLE REGASIFICATION SERVICE" and such INTERRUPTIBLE REGASIFICATION SERVICE shall be allocated on a first come, first served basis.
- (h) Upon the receipt of a DAILY SEND OUT GAS NOMINATION after the day-ahead nomination cycle pursuant to AA 7.11(c), OPERATOR shall allocate the TOTAL REGASIFICATION CAPACITY in the same manner as provided in AA 7.11(g)(iii). As a consequence, CAPACITY USER acknowledges that any nomination of INTERRUPTIBLE REGASIFICATION SERVICE that was confirmed for a GAS DAY may be interrupted as necessary to make available for delivery any REGASIFICATION CAPACITY USER'S daily firm contractual entitlement to receive regasified NATURAL GAS.
- (i) Following the submission of DAILY SEND OUT GAS NOMINATION for any GAS DAY, and the subsequent submission of revised DAILY SEND OUT GAS NOMINATIONS, OPERATOR shall notify each REGASIFICATION CAPACITY USER of the amount of any DAILY SEND OUT GAS NOMINATION accepted by OPERATOR including the amount of any nominated INTERRUPTIBLE REGASIFICATION SERVICE to be provided.
- (j) In the event of a reduction in TOTAL REGASIFICATION CAPACITY during any GAS DAY with respect to which INTERRUPTIBLE REGASIFICATION SERVICE has been scheduled, OPERATOR shall discontinue any INTERRUPTIBLE REGASIFICATION SERVICE in accordance with AA 4.2.

- (k) If CAPACITY USER submits a DAILY SEND OUT GAS NOMINATION for delivery of SEND OUT GAS that is greater than the quantity of LNG CAPACITY USER has stored, or will have stored, in the LNG STORAGE TANKS, OPERATOR will notify CAPACITY USER and shall, in consultation with CAPACITY USER modify the DAILY SEND OUT GAS NOMINATION to a quantity of SEND OUT GAS that is equivalent to the quantity of LNG CAPACITY USER has stored in the LNG STORAGE TANK (net of MINIMUM INVENTORY) at that time.
- (l) If CAPACITY USER submits a DAILY SEND OUT GAS NOMINATION for delivery of a quantity of SEND OUT GAS in any GAS DAY at a rate of delivery that is less than the MINIMUM SEND OUT RATE or more than MAXIMUM SEND OUT RATE, OPERATOR will notify CAPACITY USER that it will at OPERATOR'S discretion:
 - (i) where it is within the capability of the REGASIFICATION UNIT and where to do so would not have an adverse effect on the RECEIVING FACILITY or the other CAPACITY USERS' rights to SERVICES, as agreed by OPERATOR, accept the DAILY SEND OUT GAS NOMINATION; or
 - (ii) modify the DAILY SEND OUT GAS NOMINATION to deliver SEND OUT GAS at a rate that is not less than the MINIMUM SEND OUT RATE but not more than the MAXIMUM SEND OUT RATE.
- (m) OPERATOR shall notify CAPACITY USER promptly of its decision to accept or modify a DAILY SEND OUT GAS NOMINATION pursuant to AA 7.11(l).
- (n) Subject to AA 15.5(a) and (c), OPERATOR shall protect, indemnify, defend and hold harmless CAPACITY USER for any direct costs, losses and expenses reasonably incurred by CAPACITY USER as a result of OPERATOR'S non-compliance with a DAILY SEND OUT GAS NOMINATION which has been accepted by OPERATOR (other than as a result of an EVENT OF FORCE MAJEURE, ADVERSE WEATHER CONDITIONS, act or omission of CAPACITY USER (or its agents, contractors or subcontractors)).
- (o) In any given day, OPERATOR shall only be obligated to deliver SEND OUT GAS at the following rate per hour:

$$\text{Hourly SEND OUT GAS Rate} = \text{DAILY SEND OUT GAS NOMINATION for such day} \div 24$$

7.12 Nomination Principles

- (a) Notwithstanding any other provisions of this ACCESS ARRANGEMENT, OPERATOR shall only be required to comply with its obligations under this ACCESS ARRANGEMENT if doing so is in compliance with the FACILITY OPERATING PARAMETERS. OPERATOR shall be excused from any liability under this ACCESS ARRANGEMENT to the extent that compliance with the

issued ANNUAL OPERATION SCHEDULE, the THREE MONTH OPERATION SCHEDULE or the daily nomination for SEND OUT GAS has caused, or would cause, OPERATOR not to comply with the FACILITY OPERATING PARAMETERS.

- (b) If OPERATOR considers that it is, or will be, unable to comply with the issued ANNUAL OPERATION SCHEDULE, the THREE MONTH OPERATION SCHEDULE or the daily nomination of SEND OUT GAS whilst complying with the FACILITY OPERATING PARAMETERS, OPERATOR may reduce the send out rate of SEND OUT GAS and/or shutdown the RECEIVING FACILITY.
- (c) CAPACITY USER shall protect, indemnify, defend and hold harmless OPERATOR for and against all direct costs, losses and expenses reasonably incurred by OPERATOR in the circumstances described in AA 7.12(b) as a result of an act or omission of CAPACITY USER.
- (d) If on any GAS DAY, CAPACITY USER fails to take NATURAL GAS at a rate which would be sufficient to meet its MINIMUM SEND OUT RATE, OPERATOR shall have the right (from time to time) to use its discretion to manage the situation.
- (e) If on any GAS DAY:
 - (i) the aggregate quantity of NATURAL GAS taken by CAPACITY USER on each GAS DAY of the CONTRACT MONTH to date; plus
 - (ii) the quantity of NATURAL GAS scheduled to be made available for delivery on such GAS DAY pursuant to AA 7.11; plus
 - (iii) the quantity of NATURAL GAS nominated to be delivered on the following GAS DAY pursuant to AA 7.11, if applicable; plus
 - (iv) the sum of the SCHEDULED DAILY GAS QUANTITIES for the remaining GAS DAYS in the CONTRACT MONTH

is less than 90% (ninety per cent) of the SCHEDULED MONTHLY GAS QUANTITY or such failure is reasonably anticipated by OPERATOR to cause adverse impact on operations at the RECEIVING FACILITY (including where there may be insufficient storage space in the LNG STORAGE TANKS) during the CONTRACT MONTH and/or the following CONTRACT MONTH (a "FORECAST UNDERTAKE EVENT"), then OPERATOR shall determine the difference between (i) CAPACITY USER'S SCHEDULED DAILY GAS QUANTITIES and (ii) its MAXIMUM DAILY SEND OUT RATE for each GAS DAY of the CONTRACT MONTH, and shall have the right (from time to time) to use its discretion to manage the situation.

- (f) Upon the occurrence of a FORECAST UNDERTAKE EVENT where OPERATOR does not reasonably expect to be able to avoid adverse impact on operations at the RECEIVING FACILITY despite having first exercised reasonable efforts to utilise its authority provided under AA 7.12(e) above, OPERATOR may elect to cancel or delay unloading of one or more CARGOES, provided that:

- (i) if the affected CARGO would have been delivered for the account of CAPACITY USER who is responsible for the FORECAST UNDERTAKE EVENT, OPERATOR shall have no liability to such CAPACITY USER as a result of such cancellation or delay;
- (ii) if the affected CARGO would have been delivered for the account of other CAPACITY USERS, then CAPACITY USER who is responsible for the FORECAST UNDERTAKE EVENT shall protect, indemnify, defend and hold harmless OPERATOR against its direct costs, losses and expenses reasonably incurred in relation to such other CAPACITY USER(S) under their respective TERMINAL USE AGREEMENT(S) as a result of or in connection with such FORECAST UNDERTAKE EVENT.

In the event a CARGO delay or cancellation is caused by more than one CAPACITY USER failing to take their respective SCHEDULED DAILY GAS QUANTITY, each of the responsible CAPACITY USERS shall, subject to AA 15.5(d), protect, indemnify, defend and hold harmless OPERATOR, against its direct costs, losses and expenses reasonably incurred in relation to any other CAPACITY USER under their respective TERMINAL USE AGREEMENTS, in proportion to each CAPACITY USER'S relative failure to take its SCHEDULED DAILY GAS QUANTITY .

- (g) CAPACITY USER shall protect, indemnify, defend and hold harmless OPERATOR from its direct costs, losses and expenses reasonably incurred as a result of or in connection with the CAPACITY USER'S failure to accept redelivery of NATURAL GAS at its MINIMUM SEND OUT RATE, a FORECAST UNDERTAKE EVENT, and/or OPERATOR'S reloading or disposal of the CAPACITY USER'S LNG inventory and against OPERATOR'S liability to other CAPACITY USERS due to the CAPACITY USER'S failure to take NATURAL GAS at its MINIMUM SEND OUT RATE, and/or for a FORECAST UNDERTAKE EVENT.

8.0 LNG VESSELS' ARRIVAL AND DEPARTURE

8.1 Delivery of LNG to the RECEIVING FACILITY

- (a) CAPACITY USER shall procure (or cause to be procured) all necessary arrangements for the delivery of LNG to the LNG RECEIPT POINT at the times established pursuant to the ANNUAL OPERATION SCHEDULE and the THREE MONTH OPERATION SCHEDULE.
- (b) CAPACITY USER shall also procure PORT AND MARINE SERVICES or other support vessels required to permit the safe and efficient movement of the LNG VESSEL in its approach to and from the RECEIVING FACILITY. CAPACITY USER shall pay all PORT AND MARINE SERVICE CHARGES due for PORT AND MARINE SERVICES rendered to its LNG VESSELS.
- (c) Subject to the remaining provisions of this ACCESS ARRANGEMENT, OPERATOR shall ensure that the RECEIVING FACILITY is capable of safely and expeditiously:

- (i) receiving; and
 - (ii) having LNG discharged from, or loaded to,
- all LNG VESSELS that comply with the requirements of AA 6.0.

8.2 **Notice of Estimated Time of Arrival at the RECEIVING FACILITY**

(a) First Notice

CAPACITY USER shall as soon as reasonably practicable give or procure that the MASTER gives notice to OPERATOR of the date and the time at which each LNG VESSEL has departed from the PREVIOUS PORT en route to the RECEIVING FACILITY and the estimated date and time of arrival of such LNG VESSEL at the PILOT BOARDING STATION (the "ESTIMATED TIME OF ARRIVAL" or "ETA"). CAPACITY USER shall include the following information in such notice to OPERATOR:

- (i) the quantity of LNG in that LNG VESSEL;
 - (ii) the name of the LNG VESSEL;
 - (iii) the PREVIOUS PORT from which the LNG VESSEL has departed;
 - (iv) any operational deficiencies in that LNG VESSEL that may affect its port performance; and
 - (v) the specification of any LNG in that LNG VESSEL at the time of the notice of ETA.
- (b) CAPACITY USER shall ensure that the MASTER promptly notifies OPERATOR of any change in the ETA. If the condition of the LNG VESSEL changes due to circumstances discovered after transmittal of any notice issued under this AA 8.2, CAPACITY USER shall ensure that the MASTER shall give prompt notice thereof to OPERATOR, setting forth the information required by AA 8.2(a) above and amending the information previously given to OPERATOR.

(c) Second Notice

Ninety-six (96) hours before the arrival of the LNG VESSEL at the PILOT BOARDING STATION, CAPACITY USER shall ensure that the MASTER shall give notice to OPERATOR confirming or amending the FIRST NOTICE and giving an actual time during the SCHEDULED DATE OF ARRIVAL that the MASTER reasonably considers that that LNG VESSEL should arrive at the PILOT BOARDING STATION and be ready to proceed to berth at the RECEIVING FACILITY. If this ETA subsequently changes by more than six (6) hours, CAPACITY USER shall ensure that the MASTER shall promptly give notice of the corrected ETA to OPERATOR.

(d) Third Notice

Seventy-two (72) hours before the arrival of the LNG VESSEL at the PILOT BOARDING STATION, CAPACITY USER shall ensure that the MASTER shall

give notice to OPERATOR confirming or amending the SECOND NOTICE. If this ETA subsequently changes by more than six (6) hours, CAPACITY USER shall ensure that the MASTER shall promptly give notice of the corrected ETA to OPERATOR.

(e) Fourth Notice

Forty-eight (48) hours before the arrival of the LNG VESSEL at the PILOT BOARDING STATION, CAPACITY USER shall ensure that the MASTER shall give notice to OPERATOR confirming or amending the THIRD NOTICE. If this ETA subsequently changes by more than two (2) hours, CAPACITY USER shall ensure that the MASTER shall give prompt notice of the corrected ETA to OPERATOR.

(f) Fifth Notice

Twenty-four (24) hours before the arrival of the LNG VESSEL at the PILOT BOARDING STATION, CAPACITY USER shall ensure that the MASTER shall give notice to OPERATOR confirming or amending the FOURTH NOTICE. If this ETA subsequently changes by more than two (2) hours, CAPACITY USER shall ensure that the MASTER shall give prompt notice of the corrected ETA to OPERATOR.

(g) Final Notice

CAPACITY USER shall cause the MASTER to send a final ETA notice to OPERATOR six (6) hours before the arrival of the LNG VESSEL at the PILOT BOARDING STATION.

(h) CAPACITY USER shall cause the MASTER, in addition to the notices referred to above, to give such notices at such times as may be required in order to comply with any APPLICABLE LAWS and/or any AUTHORISATIONS (including any requirements of MMS).

(i) All notices to be given pursuant to this AA 8.2 shall be given by e-mail in English or, if notification by e-mail is not possible, by facsimile in English, or if notification by facsimile is not possible, by telephone in English.

(j) OPERATOR shall keep the MASTER updated at all times and shall provide as much notice as is reasonably practicable to the MASTER and CAPACITY USER of any operational difficulties at the RECEIVING FACILITY that OPERATOR believes may adversely affect or delay the LNG VESSEL from berthing at the RECEIVING FACILITY and discharging its LNG.

8.3 NOTICE OF READINESS at Pilot Boarding Station

(a) Upon arrival of an LNG VESSEL at the PILOT BOARDING STATION, CAPACITY USER shall cause the MASTER of the LNG VESSEL to tender a notice of readiness to OPERATOR ("NOTICE OF READINESS") by electronic mail or facsimile indicating the LNG VESSEL'S state of readiness, having cleared the necessary formalities, to proceed to the RECEIVING FACILITY and discharge or reload LNG.

- (b) A NOTICE OF READINESS tendered to OPERATOR pursuant to AA 8.3(a) shall:
 - (i) be in written form;
 - (ii) be in English;
 - (iii) be signed by the MASTER for and on behalf of CAPACITY USER;
 - (iv) state the time upon which the NOTICE OF READINESS is being given; and
 - (v) be addressed to OPERATOR (or its duly authorised representative).
- (c) Following service of the NOTICE OF READINESS, OPERATOR shall cause the LNG VESSEL concerned to be berthed safely and expeditiously at the berth of the RECEIVING FACILITY and CAPACITY USER shall cause the MASTER to cooperate in the LNG VESSEL being safely and expeditiously berthed.
- (d) In the event that the LNG VESSEL arrives at the RECEIVING FACILITY prior to the SCHEDULED DATE OF ARRIVAL for the applicable CARGO, the NOTICE OF READINESS shall be deemed effective at the earlier of:
 - (i) six (6) hours after the start of RECEIVING FACILITY operating hours on the first Day of the SCHEDULED DATE OF ARRIVAL as specified in the TERMINAL INFORMATION BOOKLET; or
 - (ii) the time at which the LNG VESSEL is berthed, all fast and ready to unload or reload.
- (e) In the event that the LNG VESSEL arrives at the RECEIVING FACILITY within the SCHEDULED DATE OF ARRIVAL for the applicable CARGO, the NOTICE OF READINESS shall be deemed effective at:
 - (i) if NOTICE OF READINESS is given outside the RECEIVING FACILITY'S operating hours as specified in the TERMINAL INFORMATION BOOKLET, the earlier of:
 - (A) six (6) hours after the start of the RECEIVING FACILITY'S next operating hours as specified in the TERMINAL INFORMATION BOOKLET; and
 - (B) the time at which the LNG VESSEL is berthed, all fast and ready to unload or reload;
 - (ii) if NOTICE OF READINESS is given during the RECEIVING FACILITY operating hours as specified in the TERMINAL INFORMATION BOOKLET, the earlier of:
 - (A) six (6) hours after the NOTICE OF READINESS is given or, if such time is outside the RECEIVING FACILITY'S operating hours as specified in the TERMINAL INFORMATION BOOKLET, six (6) hours after the start of the RECEIVING FACILITY'S next operating

hours as specified in the TERMINAL INFORMATION BOOKLET;
and

- (B) the time at which the LNG VESSEL is berthed, all fast and ready to unload or reload.
- (f) In the event that the LNG VESSEL arrives at the RECEIVING FACILITY after the SCHEDULED DATE OF ARRIVAL, the NOTICE OF READINESS shall be deemed effective at the time at which the LNG VESSEL is berthed, all fast and ready to unload or reload.
- (g) OPERATOR shall provide or cause to provide a safe berth, unloading and reloading facilities at the RECEIVING FACILITY. OPERATOR shall operate (or cause to be operated) the RECEIVING FACILITY so as to permit discharge or reload of CARGOES as safely, quickly and efficiently as reasonably possible and departure of LNG VESSEL.
- (h) CAPACITY USER shall cause the LNG VESSEL to depart safely and as expeditiously as reasonably possible from berth after completion of unloading or reloading in cooperation with OPERATOR.
- (i) In the event that OPERATOR gives the MASTER a notice indicating that the RECEIVING FACILITY will be unable to receive the LNG VESSEL on the SCHEDULED DATE OF ARRIVAL (and indicating a delayed time and day on which the RECEIVING FACILITY will be able to receive that LNG VESSEL being the "REVISED BERTHING TIME") (other than as a result of an EVENT OF FORCE MAJEURE, ADVERSE WEATHER CONDITIONS, act or omission of CAPACITY USER (or its agents, contractors or subcontractors)) and as a direct result of such notice the MASTER (acting as a REASONABLE AND PRUDENT OPERATOR) delays the arrival of the LNG VESSEL at the PILOT BOARDING STATION then OPERATOR shall, subject to AA 15.5(a), protect, indemnify, defend and hold harmless CAPACITY USER for the direct additional costs incurred by CAPACITY USER in delaying the arrival of such LNG VESSEL until the REVISED BERTHING TIME.
- (j) A claim made pursuant to AA 8.3(i) will only be considered by OPERATOR if a substantially documented claim is received (or if all documents are not available to CAPACITY USER, notice of a formal claim is advised by CAPACITY USER with an estimate of the amount requested) within ninety (90) days from the end of the original SCHEDULED DATE OF ARRIVAL for the LNG VESSEL. If no such claim is made within the said ninety (90) day period, OPERATOR shall be discharged and released from all liability in respect of any claims that CAPACITY USER may have hereunder in respect of such LNG VESSEL.

8.4 **ALLOWED UNLOADING TIME and ALLOWED RELOADING TIME**

- (a) Subject to AA 8.4(f), OPERATOR shall:
 - (i) in the case of unloading operations, be allocated the "ALLOWED UNLOADING TIME" as follows:

- (A) thirty six (36) hours for LNG VESSELS with maximum cargo capacity between **120,000 m³** and **145,000 m³**;
 - (B) forty (40) hours for LNG VESSELS with maximum cargo capacity greater than **145,000 m³** and up to **180,000 m³**; and
 - (C) forty eight (48) hours for LNG VESSELS with maximum cargo capacity greater than **180,000 m³** and up to **270,000 m³**; and
- (ii) in the case of reloading operations, be allocated the "ALLOWED RELOADING TIME" as follows:
- (A) twenty four (24) hours for LNG VESSELS with maximum cargo capacity between **5,000 m³** and **18,000 m³**;
 - (B) forty seven (47) hours for LNG VESSELS with maximum cargo capacity greater than **18,000 m³** and up to **100,000 m³**; and
 - (C) sixty (60) hours for LNG VESSELS with maximum cargo capacity greater than **100,000 m³** to **150,000 m³**.
 - (D) ninety (90) hours for LNG VESSELS with maximum cargo capacity greater than **150,000 m³** to **270,000 m³**.

OPERATOR may, from time to time, propose amendments in accordance with AA 29.1(a) to adjust the ALLOWED UNLOADING TIME and ALLOWED RELOADING TIME to reflect the RECEIVING FACILITY'S actual performance.

- (b) To the extent that USED LAYTIME exceeds the ALLOWED UNLOADING TIME or ALLOWED RELOADING TIME, as applicable, CAPACITY USER shall be entitled to submit a claim to OPERATOR for:
- (i) demurrage payments to reimburse CAPACITY USER for any resulting direct costs, losses and expenses reasonably incurred by CAPACITY USER'S LNG VESSEL (where CAPACITY USER ships its own LNG), or for liability to CAPACITY USER'S LNG suppliers for demurrage; and
 - (ii) boil-off payments to reimburse CAPACITY USER for excess boil-off gas incurred by the CAPACITY USER'S LNG VESSEL (where CAPACITY USER ships its own LNG), or for liability to the CAPACITY USER'S LNG suppliers for excess boil-off gas, as a result of such delay,

which have been reasonably and properly incurred.

- (c) A demurrage or excess boil-off claim pursuant to this AA 8.4 will only be considered by OPERATOR if a fully documented claim is received (or if all documents are not available to CAPACITY USER, notice of a formal claim is advised by CAPACITY USER with an estimate of the amount requested) within ninety (90) days from the end of the USED LAYTIME. If no such claim is made within the said ninety (90) day period, OPERATOR shall be discharged and released from all liability in respect of any demurrage claims that CAPACITY USER may have under this paragraph in respect of such USED LAYTIME in

excess of the ALLOWED UNLOADING TIME or ALLOWED RELOADING TIME, as the case may be.

- (d) OPERATOR'S liability pursuant to AA 8.4(b) shall be CAPACITY USER'S exclusive remedy in respect of any delay in discharging LNG from or reloading LNG into the LNG VESSEL.
- (e) USED LAYTIME shall:
 - (i) start when the NOTICE OF READINESS is deemed to be effective pursuant to AA 8.3(d), 8.3(e) or 8.3(f), as applicable; and
 - (ii) end at the point when the unloading or loading arms are disconnected from the LNG VESSEL, the communication lines to that LNG VESSEL have been disconnected and OPERATOR has given the MASTER notice that OPERATOR is ready to remove the gangway from the LNG VESSEL's deck.
- (f) The ALLOWED UNLOADING TIME and ALLOWED RELOADING TIME shall be extended by any period of delay which is caused by one or more of the following:
 - (i) reasons attributable to CAPACITY USER, the LNG VESSEL or its MASTER;
 - (ii) EVENT OF FORCE MAJEURE;
 - (iii) ADVERSE WEATHER CONDITIONS which prevent the LNG VESSEL from proceeding to berth, berthing, unloading, loading or departing;
 - (iv) occupancy of the berth by a previous LNG VESSEL where that occupancy is due to reasons attributable to that LNG VESSEL;
 - (v) time during which normal operation at the RECEIVING FACILITY is prohibited by law, regulation or decree;
 - (vi) restrictions imposed by port authorities on the movement of LNG vessels; and
 - (vii) restrictions due to the state of the tide at the PENGERANG DEEPWATER TERMINAL

8.5 PERMITTED BERTH OCCUPANCY TIME

- (a) Subject to AA 8.5(e) and AA 8.6, CAPACITY USER shall be allocated the "PERMITTED BERTH OCCUPANCY TIME" as follows:
 - (A) Forty eight (48) hours for LNG VESSELS with maximum cargo capacity between **120,000 m³** and **145,000 m³**;
 - (B) Fifty two (52) hours for LNG VESSELS with maximum cargo capacity greater than **145,000 m³** and up to **180,000 m³**; and

- (C) Sixty (60) hours for LNG VESSELS with maximum cargo capacity greater than **180,000 m³** and up to **270,000 m³**.
- (b) To the extent that USED LAYTIME for an LNG VESSEL exceeds the PERMITTED BERTH OCCUPANCY TIME, as applicable, OPERATOR shall be entitled to submit a claim to CAPACITY USER for any direct costs, losses and expenses reasonably incurred by OPERATOR as a result of or in connection with the USED LAYTIME exceeding the PERMITTED BERTH OCCUPANCY TIME.
- (c) A claim pursuant to this AA 8.5 will only be considered by CAPACITY USER if a fully documented claim is received (or if all documents are not available to OPERATOR, notice of a formal claim is advised by OPERATOR with an estimate of the amount requested) within ninety (90) days from the end of the USED LAYTIME. If no such claim is made within the said ninety (90) day period, CAPACITY USER shall be discharged and released from all liability in respect of any demurrage claims that OPERATOR may have under this paragraph in respect of such USED LAYTIME in excess of the PERMITTED BERTH OCCUPANCY TIME.
- (d) CAPACITY USER'S liability pursuant to AA 8.5(b) shall be CAPACITY USER'S exclusive remedy in respect of any delay in unloading LNG and departing the berth.
- (e) The PERMITTED BERTH OCCUPANCY TIME shall be extended by any period of delay which is caused by one or more of the following:
- (i) reasons solely attributable to OPERATOR;
 - (ii) EVENT OF FORCE MAJEURE;
 - (iii) ADVERSE WEATHER CONDITIONS which prevent the LNG VESSEL from proceeding to berth, berthing, unloading, loading or departing;
 - (iv) occupancy of the berth by a previous LNG VESSEL where that occupancy is due to reasons attributable to that LNG VESSEL;
 - (v) time during which normal operation at the RECEIVING FACILITY is prohibited by law, regulation or decree;
 - (vi) restrictions imposed by the port authorities on the movement of LNG vessels; and
 - (vii) restrictions due to the state of the tide at the Pengerang Deepwater Terminal with the reasonable notice by MMS.

8.6 **Departure from the RECEIVING FACILITY**

- (a) The LNG VESSEL shall depart the RECEIVING FACILITY as soon as reasonably practicable after discharging or loading its CARGO, unless otherwise permitted or prevented by OPERATOR.
- (b) If an LNG VESSEL has not departed the RECEIVING FACILITY by the end of the period referred to in AA 8.6(a):
 - (i) OPERATOR may, by notice to CAPACITY USER, order that LNG VESSEL off the jetty of the RECEIVING FACILITY and CAPACITY USER shall comply, and shall ensure that the MASTER complies, with such order; and
 - (ii) CAPACITY USER shall protect, indemnify, defend and hold harmless OPERATOR for and against any direct costs, losses and expenses (including any demurrage or equivalent claims by other CAPACITY USERS) reasonably incurred by OPERATOR arising out of, or in connection with, the LNG VESSEL not having departed the RECEIVING FACILITY in accordance with this AA 8.6 that it would not have otherwise incurred had the LNG VESSEL departed in accordance with this AA 8.6.

8.7 Repairs

- (a) Save as otherwise set out in this ACCESS ARRANGEMENT, CAPACITY USER shall not carry out, and shall procure that the MASTER does not carry out, or allow to be carried out, any repairs to any LNG VESSELS whilst moored at the jetty of the RECEIVING FACILITY.
- (b) CAPACITY USER and/or the MASTER may carry out, or allow to be carried out, repairs to its LNG VESSELS whilst moored at the jetty of the RECEIVING FACILITY with the consent of OPERATOR (or its authorised representative), such consent not to be unreasonably withheld or delayed in the case of minor repairs that:
 - (i) do not affect the performance by either PARTY of its obligations under the TERMINAL USE AGREEMENT; and
 - (ii) do not cause a health and/or safety risk.
- (c) When requesting the right to carry out repairs pursuant to this AA 8.7, CAPACITY USER shall, or shall ensure that the MASTER shall, give reasonable advance notice to OPERATOR (or its authorised representative) of:
 - (i) the nature of the proposed repairs;
 - (ii) the time at which CAPACITY USER wishes the proposed repairs to take place;
 - (iii) the estimated length of time that the proposed repairs will take; and
 - (iv) the risks associated with the repair work.

- (d) OPERATOR (or its authorised representative) shall be entitled to attach reasonable conditions to any consent (including the timing of such repairs) that it gives under this AA 8.7 and CAPACITY USER shall, and shall ensure that the MASTER shall, comply with such conditions.
- (e) OPERATOR'S consent shall not be withheld or delayed in relation to the carrying out of any repair required by APPLICABLE LAWS or AUTHORISATION to enable an LNG VESSEL to be navigated in Malaysian territorial waters where such repairs cannot reasonably be carried out anywhere other than at the RECEIVING FACILITY.
- (f) Except to the extent necessary to make repairs referred to in AA 8.7(e), CAPACITY USER shall ensure that whilst berthed at the RECEIVING FACILITIES, the main engines and related auxiliaries of its LNG VESSELS shall be kept in a state of readiness such that that the LNG VESSEL can leave the RECEIVING FACILITY under its own power in an emergency.
- (g) CAPACITY USER shall protect, indemnify, defend and hold harmless OPERATOR for and against any direct costs, losses and expenses reasonably incurred by it arising out of, or in connection with, any repair to an LNG VESSEL carried out that it would not have otherwise incurred had the repair to the LNG VESSEL not been carried out.
- (h) Notwithstanding any other provision of this ACCESS ARRANGEMENT but except to the extent necessary to make repairs referred to in AA 8.7(e), CAPACITY USER shall not, and shall ensure that the MASTER does not, allow any repairs to be made to an LNG VESSEL whilst berthed at the RECEIVING FACILITY that may, in the reasonable opinion of OPERATOR, impair or limit the use of:
 - (i) that LNG VESSEL's fire detection and/or firefighting capability; or
 - (ii) any apparatus relating to the safe and efficient handling of LNG; or
 - (iii) the propulsion system or manoeuvrability of that LNG VESSEL; or
 - (iv) the mooring system of that LNG VESSEL; or
 - (v) the shore communications systems or linked emergency shutdown systems; or
 - (vi) lead to the operation of electrical equipment in gas dangerous zones,save where adequate safety provisions and safety solutions have been agreed with OPERATOR and implemented beforehand.

8.8 **Early or Late Arrival**

- (a) If an LNG VESSEL arrives at the PILOT BOARDING STATION before, during or after its SCHEDULED DATE OF ARRIVAL, OPERATOR shall give priority in the berthing of LNG VESSELS, in the following order to:

- (i) LNG VESSELS in respect of which a NOTICE OF READINESS is received by OPERATOR during its SCHEDULED DATE OF ARRIVAL; then
- (ii) LNG VESSELS in respect of which a NOTICE OF READINESS is received after its SCHEDULED DATE OF ARRIVAL (a "LATE LNG VESSEL"); then
- (iii) LNG VESSELS in respect of which a NOTICE OF READINESS is received prior to its SCHEDULED DATE OF ARRIVAL (an "EARLY LNG VESSEL"),

provided that, LATE LNG VESSEL shall not have priority over an EARLY LNG VESSEL if in OPERATOR'S discretion, the result of unloading the LATE LNG VESSEL would be that the EARLY LNG VESSEL would not be able to berth on its SCHEDULED DATE OF ARRIVAL and, as between LNG VESSELS falling within each of the categories specified in AA 8.8(a)(i), 8.8(a)(ii) and 8.8(a)(iii) above, shall give priority on a "first come, first served" basis.

- (b) Notwithstanding AA 8.8(a), OPERATOR may allow an EARLY LNG VESSEL or a LATE LNG VESSEL to berth and shall receive LNG from such LNG VESSEL at the first available opportunity where to do so will not, in the reasonable opinion of OPERATOR:
 - (i) prejudice the safe operation of the RECEIVING FACILITY and/or cause a health and/or safety risk at the RECEIVING FACILITY; or
 - (ii) cause any adverse effect on the provision of the SERVICES to any CAPACITY USER.
- (c) OPERATOR may refuse to allow a LATE LNG VESSEL to berth unless OPERATOR reasonably determines that the berthing and unloading of such LATE LNG VESSEL will not interfere with berthing and unloading by any scheduled vessel and will not disrupt the overall unloading schedule or operations of the RECEIVING FACILITY. Notwithstanding the foregoing, OPERATOR may allow a LATE LNG VESSEL to berth, subject always to AA 8.8(d) below.
- (d) CAPACITY USER shall protect, indemnify, defend and hold harmless OPERATOR for and against any direct costs, losses and expenses reasonably incurred by OPERATOR arising out of or in connection with OPERATOR allowing an EARLY LNG VESSEL or a LATE LNG VESSEL to berth and receiving LNG before or after the SCHEDULED DATE OF ARRIVAL that it would not have otherwise incurred had OPERATOR not allowed that LNG VESSEL at CAPACITY USER'S request to berth and receive LNG before or after the SCHEDULED DATE OF ARRIVAL.

8.9 Co-operation

The PARTIES shall co-operate with each other and use REASONABLE ENDEAVOURS to minimise or avoid any delays to berthing of LNG VESSELS,

discharging of LNG and the departure of a VESSEL from the RECEIVING FACILITIES.

8.10 Conditions of Use

CAPACITY USER shall ensure that the MASTER of an LNG VESSEL shall sign the conditions of use and such other documents as per TIB (if any) or other competent authority may from time to time require.

8.11 MASTER of LNG VESSEL

For the avoidance of doubt, the acts and/or omissions of the MASTER of an LNG VESSEL shall be deemed to be the acts and/or omissions of CAPACITY USER for the purposes of the TERMINAL USE AGREEMENT.

8.12 Night Berthing and Tide Restrictions

- (a) CAPACITY USER shall not permit an LNG VESSEL to berth at the RECEIVING FACILITY during the period of night berthing restrictions set out in the TERMINAL INFORMATION BOOKLET advised by OPERATOR.
- (b) CAPACITY USER shall not permit an LNG VESSEL to berth at, or depart from the RECEIVING FACILITY where it is not practicable to do so given the state of the tide.

8.13 Communication Protocol

The PARTIES shall adhere to the COMMUNICATION PROTOCOL.

9.0 RECEIVING FACILITY

9.1 Standard Of Operation

OPERATOR shall at all times on and from the SERVICE COMMENCEMENT DATE operate and maintain (or cause to be operated and maintained) the RECEIVING FACILITY in accordance with all APPLICABLE LAWS, AUTHORISATIONS and INTERNATIONAL LNG TERMINAL STANDARDS.

9.2 Modifications to RECEIVING FACILITY

- (a) OPERATOR is entitled, with the approval of the ENERGY COMMISSION, to modify the RECEIVING FACILITY at any time if such modification is necessary in order for OPERATOR to comply with a change in INTERNATIONAL LNG TERMINAL STANDARDS or any APPLICABLE LAWS with which the RECEIVING FACILITY is required to comply.
- (b) OPERATOR shall notify CAPACITY USER in writing prior to the commencement of any modification works and OPERATOR shall provide information to CAPACITY USER on whether such modifications will have an impact on the FEE.

9.3 Modifications to LNG VESSELS

- (a) In the event an LNG VESSEL (which was previously approved by OPERATOR and previously compatible with the RECEIVING FACILITY) is required to be modified in order to maintain compatibility with the RECEIVING FACILITY following any modification of the RECEIVING FACILITY pursuant to AA 9.2, the costs of such modification shall be borne by CAPACITY USER.

9.4 **CAPACITY USER'S Inspection Rights**

- (a) CAPACITY USER may, with the prior written consent of OPERATOR (such consent not to be unreasonably withheld or delayed), appoint a reasonable number of designated representatives (including LNG suppliers) to inspect the operation of the RECEIVING FACILITY (including during initial construction), provided that such inspection shall occur during business hours in Malaysia.
- (b) Any inspection under AA 9.4(a) shall be at CAPACITY USER'S sole risk and expense and shall be carried out without any interference with or hindrance to the safe and efficient operation of the RECEIVING FACILITY or construction works at the RECEIVING FACILITY.
- (c) CAPACITY USER'S right to inspect and examine the RECEIVING FACILITY under AA 9.4(a) shall be limited to verifying OPERATOR'S compliance with OPERATOR'S obligations under this ACCESS ARRANGEMENT and shall not entitle CAPACITY USER to make direct requests to OPERATOR regarding any aspect of the RECEIVING FACILITY, provided however that CAPACITY USER shall notify OPERATOR of any matters which CAPACITY USER discovers in the course of the inspection and examination, that, in CAPACITY USER'S reasonable opinion, amount to a breach of AA 9.1.
- (d) No inspection (or lack thereof) or approval of the RECEIVING FACILITY by CAPACITY USER, or any requests or observations made to OPERATOR or its representatives by or on behalf of CAPACITY USER in connection with any such inspection or approval, shall of itself:
 - (i) modify or amend OPERATOR'S obligations, representations, warranties and covenants under the TERMINAL USE AGREEMENT; or
 - (ii) constitute an acceptance or waiver by CAPACITY USER of OPERATOR'S obligations under the TERMINAL USE AGREEMENT.
- (e) Other than as permitted under this AA 9.4 or as otherwise agreed by OPERATOR in its discretion, no employee, contractor, agent, visitor or supplier of CAPACITY USER shall be permitted to access the RECEIVING FACILITY at any time during the TERM.

9.5 **Licence to use RECEIVING FACILITY**

If and when so required by APPLICABLE LAWS, CAPACITY USER shall obtain a licence to use the RECEIVING FACILITY from the relevant regulatory body and maintain such licence for the remainder of the TERM.

9.6 **TERMINAL INFORMATION BOOKLET**

- (a) The information relating to the operations between the LNG VESSEL and the RECEIVING FACILITY during the arrival, discharge, loading and departure of the LNG VESSEL within the PENERANG DEEPWATER TERMINAL shall be outlined in the TERMINAL INFORMATION BOOKLET.
- (b) The TERMINAL INFORMATION BOOKLET shall be developed by OPERATOR and shared with CAPACITY USER on or before the SERVICE COMMENCEMENT DATE. .
- (c) CAPACITY USER shall comply with, and shall ensure that its LNG VESSELS, their MASTERS and crew comply with, the TERMINAL INFORMATION BOOKLET.
- (d) OPERATOR may from time to time amend and/or update the TERMINAL INFORMATION BOOKLET for operational purposes or to comply with any APPLICABLE LAWS or rules or regulations of any GOVERNMENTAL AUTHORITY having jurisdiction over OPERATOR and/or the RECEIVING FACILITY. Notwithstanding the foregoing, OPERATOR shall, where reasonably practicable, consult with CAPACITY USER prior to making any such amendments or updates. Should the amendments made in the TERMINAL INFORMATION BOOKLET contradict the requirements put forth in the ACCESS ARRANGEMENT, OPERATOR shall obtain approval from the ENERGY COMMISSION in accordance with AA 29.1.

10.0 **MEASUREMENT, ALLOCATION AND RECORDS**

10.1 **Measurement and Allocation Rules**

- (a) The measurement of:
 - (i) the specification of LNG transferred at the LNG RECEIPT POINT and the LNG RELOAD DELIVERY POINT;
 - (ii) quantities of LNG and NATURAL GAS in the LNG STORAGE TANKS; and
 - (iii) the quantity and the specification of SEND OUT GAS at the SEND OUT GAS METERING STATION

shall be carried out by OPERATOR in accordance with the MEASUREMENT RULES as set out in Schedule 2.

The measurement of the quantity of LNG transferred at the LNG RECEIPT POINT and the LNG RELOAD DELIVERY POINT shall be carried out or caused to be carried out by CAPACITY USER.

- (b) OPERATOR shall allocate, as between each CAPACITY USER, the quantity of SEND OUT GAS sent out in accordance with the ALLOCATION RULES in Schedule 6.

- (c) OPERATOR shall ensure that all records of measurements, allocations and the computation results are kept and held available to CAPACITY USER for a period of not less than seven (7) years in addition to the remainder of the then current CONTRACT YEAR after such measurements, allocations and computations have been completed.
- (d) Any DISPUTE between the PARTIES regarding this AA 10.1 is to be determined by an EXPERT in accordance with AA 37.0

10.2 **Audit Rights**

- (a) Upon the request of CAPACITY USER, OPERATOR shall:
 - (i) inspect, test and verify the meters and all other equipment installed at the RECEIVING FACILITY for the purpose of measuring the:
 - (A) quantity;
 - (B) quality and specificationsof SEND OUT GAS delivered by OPERATOR at the NATURAL GAS DELIVERY POINT; and
 - (ii) inspect, test and verify the meters and all other equipment installed at the RECEIVING FACILITY for the purpose of measuring the quantity, quality and specifications of LNG delivered by CAPACITY USER at the LNG RECEIPT POINT or to CAPACITY USER at the LNG RELOAD DELIVERY POINT. The test results will be provided to CAPACITY USER and CAPACITY USER will be entitled to an independent verification of these results.
- (b) Subject to AA 10.2(c) CAPACITY USER shall reimburse OPERATOR in respect of the direct costs, losses and expenses reasonably incurred by OPERATOR in connection with any inspection, testing, verification or calibration requested pursuant to AA 10.2(a).
- (c) In the event such inspection, testing or verification discloses errors or inaccuracies that require any adjustment, modification or upgrade at the RECEIVING FACILITY for the purpose of measuring the quantity, quality and specifications of SEND OUT GAS delivered by OPERATOR at the NATURAL GAS DELIVERY POINT or LNG delivered by CAPACITY USER at the LNG RECEIPT POINT or to CAPACITY USER at the LNG RELOAD DELIVERY POINT, such costs, losses and expenses shall be borne by OPERATOR.
- (d) The permissible tolerances of inaccuracy of the meters and all other equipment installed at the SEND OUT GAS METERING STATION and LNG RECEIPT POINT and LNG RELOAD DELIVERY POINT shall be as described in Schedule 2. Where the inaccuracy of a meter and/or any equipment is found to exceed permissible tolerances, such meter and/or equipment shall be adjusted accordingly and recordings and computations made on the basis of those recordings shall be corrected with respect to any period of error which is definitely known to, or agreed between CAPACITY USER and OPERATOR. In

the event that the period referred to above is not known to, or agreed between, the PARTIES, the related correction shall be made with respect to the LNG or SEND OUT GAS delivered during the last half of the period from the date of the most recent calibration of the inaccurate meter and/or equipment to the date on which the inaccuracy is corrected.

- (e) Any DISPUTE between the PARTIES regarding this AA 10.2 is to be determined by an EXPERT in accordance with AA 37.0.

10.3 **Inventory Balancing**

- (a) At the end of each GAS DAY, OPERATOR shall notify CAPACITY USER via electronic mail or other electronic means of the daily reporting of its LNG inventory specifying:
 - (i) SEND OUT GAS delivered for such GAS DAY;
 - (ii) LNG remaining in the LNG STORAGE TANKS at the end of such GAS DAY;
 - (iii) INTERNAL GAS CONSUMPTION borne by CAPACITY USER pursuant to AA 16.0);
 - (iv) LNG discharged from or loaded onto any LNG VESSEL (as per the report issued by the LNG VESSEL to OPERATOR);
 - (v) the volume of LNG borrowed from each other CAPACITY USER pursuant to the INTER-CAPACITY USER AGREEMENT; and
 - (vi) the volume of LNG made available to each other CAPACITY USER pursuant to the INTER-CAPACITY USER AGREEMENT.
- (b) CAPACITY USER shall promptly give notice to OPERATOR of any assignment of LNG stored in the LNG STORAGE TANKS by CAPACITY USER in accordance with AA 10.6 specifying:
 - (i) the amount of LNG in m³;
 - (ii) the purchaser; and
 - (iii) the date and time on which such sale is to take effect.

10.4 In the event that three (3) months prior to the expiry of the TERM any of CAPACITY USER'S LNG inventory is remaining in the LNG STORAGE TANKS, OPERATOR shall inform such CAPACITY USER how it proposes to manage the remaining inventory before the end of the TERM.

10.5 If at the end of the TERM any of CAPACITY USER'S LNG inventory is remaining in the LNG STORAGE TANKS, OPERATOR shall have the right to dispose of such remaining inventory as OPERATOR in its discretion sees fit without any liability to such CAPACITY USER.

10.6 **Assignment of CAPACITY USER'S LNG inventory**

Open

- (a) Subject to giving OPERATOR prior written notice, CAPACITY USER may:
 - (i) transfer or assign to any other CAPACITY USER all or any portion of the LNG being held in storage at the RECEIVING FACILITY as part of CAPACITY USER'S LNG inventory; or
 - (ii) take an assignment from any other CAPACITY USER of all or a portion of the LNG being held in storage at the RECEIVING FACILITY for the account of such other CAPACITY USER,provided, however, that:
 - (A) the transferring CAPACITY USER provides written notification, and the transferee CAPACITY USER provides written confirmation, in both cases to OPERATOR, of the effective date of such transfer and total quantity (in m³) of inventory so transferred;
 - (B) such transfer shall be made effective (1) as of the beginning of the day specified in the transferor CAPACITY USER'S notice, provided that the notification and confirmation required in AA 10.6(a)(A) above are provided by the applicable deadline for day ahead nominations for SEND OUT GAS in accordance with AA 7.11(c); or (2) the date notified by the transferor and confirmed by transferee;
 - (C) no such assignment shall be permitted to the extent that it would result in the transferee CAPACITY USER exceeding its STORAGE SERVICES ENTITLEMENT; and
 - (D) such transfer would not cause any adverse operations at the RECEIVING FACILITY.
- (b) Upon receiving such notification, OPERATOR shall adjust the respective inventory accounts of CAPACITY USER and such other CAPACITY USER in accordance with AA 10.3 and paragraph 4 of Schedule 6.

10.7 **Maintenance of MINIMUM HEEL REQUIREMENT**

- (a) OPERATOR shall ensure that, during the TERM, the quantity of LNG stored in the LNG STORAGE TANKS is equal to or greater than the MINIMUM HEEL REQUIREMENT.
- (b) If, due to or as a result of the default or negligence of OPERATOR, the quantity of LNG stored in the LNG STORAGE TANKS is less than the MINIMUM HEEL REQUIREMENT and CAPACITY USER incurs any direct costs, losses and expenses reasonably incurred as a result thereof, OPERATOR shall protect, indemnify, defend and hold harmless CAPACITY USER against such direct costs, losses and expenses reasonably incurred.

11.0 MAINTENANCE

11.1 Scheduled Maintenance

- (a) OPERATOR will develop (in consultation with CAPACITY USERS) and publish the ANNUAL MAINTENANCE PROGRAMME for the following CONTRACT YEAR on the same date that the ANNUAL OPERATION SCHEDULE is issued pursuant to AA 7.6, specifying OPERATOR'S best forecast of the following:
 - (i) the applicable dates and reason(s) for any shutdowns in the following CONTRACT YEAR;
 - (ii) the time schedule and milestones of each scheduled maintenance activity;
 - (iii) the extent to which each scheduled maintenance activity affects the normal operations of the REGASIFICATION FACILITY, including the available capacity (in the case of any PARTIAL SHUTDOWN);
 - (iv) any acts which may be required of the CAPACITY USER(s) to facilitate the shutdowns or MAINTENANCE;
 - (v) to the best of its knowledge, the planned maintenance activities as scheduled relating to the RAPID COMPLEX; and
 - (vi) such other information as may be required by the ENERGY COMMISSION.
- (b) In determining the ANNUAL MAINTENANCE PROGRAMME, OPERATOR is entitled to determine the nature of the SCHEDULED MAINTENANCE, the period of time necessary to complete such SCHEDULED MAINTENANCE and the date on which such SCHEDULED MAINTENANCE shall commence, in each case, taking into account OPERATOR'S objective to maximise the safe and reliable usage of the RECEIVING FACILITY at all times. OPERATOR shall include within each published ANNUAL MAINTENANCE PROGRAMME its then current estimate of the impact of the SCHEDULED MAINTENANCE upon its ability to provide SERVICES to CAPACITY USERS at the RECEIVING FACILITY.
- (c) OPERATOR shall:
 - (i) in carrying out and planning SCHEDULED MAINTENANCE (including any MANDATORY REGULATORY SHUTDOWN as referred to in AA 11.3) consult the CAPACITY USERS as to the scheduling of the SCHEDULED MAINTENANCE; and
 - (ii) in preparing each ANNUAL MAINTENANCE PROGRAMME:
 - (A) use REASONABLE ENDEAVOURS to coincide any SCHEDULED MAINTENANCE with the execution of any inspection, maintenance, repair, modification and/or construction relating to the PGU NETWORK and the RAPID COMPLEX that could

reasonably be expected to affect the delivery of SEND OUT GAS to the NATURAL GAS DELIVERY POINT;

- (B) use REASONABLE ENDEAVOURS to minimise (as far as practicable) the disruption of the provision of SERVICES to CAPACITY USER and other CAPACITY USERS; and
 - (C) undertake, in so far as reasonably practicable SCHEDULED MAINTENANCE during [anticipated periods of low demand to for each CONTRACT YEAR].
- (d) Any subsequent revisions of the dates of such SCHEDULED MAINTENANCE proposed by OPERATOR in the ANNUAL MAINTENANCE PROGRAMME shall first be notified by OPERATOR to ENERGY COMMISSION, then subsequently communicated by OPERATOR to CAPACITY USER as soon as reasonably practicable, but in no event later than two (2) days following the date on which OPERATOR and the ENERGY COMMISSION noted to such changes.

11.2 **Unscheduled Maintenance**

- (a) OPERATOR may, where reasonably practicable by prior written notice to CAPACITY USER, carry out UNSCHEDULED MAINTENANCE at the RECEIVING FACILITY.
- (b) Without prejudice to generality of the foregoing, CAPACITY USER acknowledges that OPERATOR:
 - (i) shall have the right to undertake a TOTAL SHUTDOWN of the FACILITIES at any time where, in OPERATOR'S sole opinion, it is necessary to do so for safety and operational reasons; and
 - (ii) shall take into consideration, to the extent possible, the opinion of the PGU NETWORK operator (as defined in the GAS SUPPLY ACT) in order to minimise disruption provided that there are no risks to the safety and integrity of the REGASIFICATION FACILITY.
- (c) Each notice provided in accordance with AA 11.2(a) above shall contain OPERATOR'S best forecast of the applicable dates and reason(s) for any shutdowns, the available capacity (in the case of any PARTIAL SHUTDOWN) and any acts which may be required of CAPACITY USER(s) to facilitate the shutdowns or MAINTENANCE (if any).
- (d) OPERATOR shall use REASONABLE ENDEAVOURS to procure that scheduled maintenance under the terms of the JETTY USAGE AGREEMENT is planned to take place at the same time as SCHEDULED MAINTENANCE in order to minimise disruption to CAPACITY USERS.

11.3 **Mandatory Regulatory Shutdown**

CAPACITY USER acknowledges that it will be necessary to perform mandatory regulatory inspections from time to time in compliance with APPLICABLE LAWS which may result in a MANDATORY REGULATORY SHUTDOWN.

11.4 Maintenance and Fees

CAPACITY USER shall continue to pay the FEE during any periods of SCHEDULED MAINTENANCE undertaken pursuant to the foregoing provisions of AA 11.1, provided that any period of MAINTENANCE which causes OPERATOR to fail to provide the SERVICES to CAPACITY USER under the relevant TERMINAL USE AGREEMENT may trigger the application of AA 5.6, AA 7.11(h) and/or AA 8.4(b), and the applicable remedies contained therein shall be CAPACITY USER'S sole and exclusive remedies against OPERATOR for its failure to provide the SERVICES due to any period of MAINTENANCE.

11.5 No Liability

- (a) Except as expressly provided in AA 11.4 above, OPERATOR shall not be liable for any costs, losses or expenses incurred by CAPACITY USER as a result of any PARTIAL SHUTDOWN or TOTAL SHUTDOWN (including any MANDATORY REGULATORY SHUTDOWN).
- (b) Notwithstanding AA 11.4, CAPACITY USER shall not be liable to OPERATOR for any costs, losses or expenses incurred by OPERATOR as a result of any PARTIAL SHUTDOWN or TOTAL SHUTDOWN (including any MANDATORY REGULATORY SHUTDOWN).

12.0 SPECIFICATION

12.1 LNG Specifications and Testing

- (a) Without prejudice to any specification parameters imposed by any APPLICABLE LAWS and/or AUTHORISATION and/or industry documents in connection with the importation of LNG into or the export of LNG from Malaysia (with which CAPACITY USER shall also comply), LNG tendered by CAPACITY USER at the LNG RECEIPT POINT or by OPERATOR at the LNG RELOAD DELIVERY POINT shall be analysed by OPERATOR in accordance with the MEASUREMENT RULES so as to ascertain the specification of that LNG in its gaseous state. Without prejudice to OPERATOR'S obligations under this AA 12.1, CAPACITY USER shall ensure that LNG tendered by CAPACITY USER at the LNG RECEIPT POINT would, if converted into its gaseous state, meet the LNG SPECIFICATIONS. Without prejudice to the CAPACITY USER'S obligations under this AA 12.1, OPERATOR shall ensure that LNG tendered by OPERATOR at the LNG RELOAD DELIVERY POINT would, if converted into its gaseous state, meet the LNG SPECIFICATIONS.
- (b) OPERATOR shall verify the LNG tendered by CAPACITY USER at the LNG RECEIPT POINT and shall accept LNG that meets the LNG SPECIFICATIONS.
- (c) CAPACITY USER shall verify the LNG tendered by OPERATOR at the LNG RELOAD DELIVERY POINT and shall accept LNG that meets the LNG SPECIFICATIONS.
- (d) OPERATOR shall analyse LNG accepted at the LNG RECEIPT POINT pursuant to AA 12.1(b) and shall provide to CAPACITY USER an LNG quality

report for the purpose of LNG custody transfer between CAPACITY USER and its LNG suppliers.

12.2 Notice of Specification of LNG

- (a) Either PARTY shall as soon as reasonably practicable notify the other PARTY if it becomes aware that the specification of the LNG being unloaded at the RECEIVING FACILITY is different from the specification previously notified to OPERATOR or does not conform with the LNG SPECIFICATIONS.
- (b) Any such notice to be provided under AA 12.2(a) shall give details of the nature and expected magnitude of the variance, including the CARGOES which are, or may be, affected.
- (c) Either PARTY shall as soon as reasonably practicable notify the other PARTY if it becomes aware that the specification of the LNG being loaded at the RECEIVING FACILITY is materially different from the specification previously notified to CAPACITY USER or does not conform with the LNG SPECIFICATIONS.
- (d) Any such notice to be provided under AA 12.2(c) shall give details of the nature and expected magnitude of the variance, including the CARGOES which are, or may be, affected.

12.3 Refusal to Accept and/or Continue Unloading OFF-SPECIFICATION LNG

- (a) If any LNG unloaded or scheduled to be unloaded in accordance with this ACCESS ARRANGEMENT fails to, or in OPERATOR'S opinion, is likely to not conform with the LNG SPECIFICATIONS, then as soon as reasonably practicable after OPERATOR becomes aware of the same, OPERATOR shall notify CAPACITY USER together with details of the reason for, and degree of such non-conformance.
- (b) If OPERATOR becomes aware before CAPACITY USER commences unloading LNG, that such LNG will not comply with the LNG SPECIFICATIONS, OPERATOR shall be entitled to suspend and/or reject delivery of all or part of the OFF-SPECIFICATION LNG and in such case:
 - (i) where OPERATOR rejects all of the OFF-SPECIFICATION LNG, neither CAPACITY USER nor the MASTER shall give its NOTICE OF READINESS, and in such case, the LNG VESSEL shall not proceed to berth (and, if proceeding to berth, shall cease to do so) at the RECEIVING FACILITY;
 - (ii) CAPACITY USER shall be solely responsible for the disposal of any rejected LNG; and
 - (iii) subject to AA 15.5(d), CAPACITY USER shall protect, indemnify, defend and hold harmless OPERATOR in accordance with AA 12.3(d).
- (c) If OPERATOR becomes aware, during the unloading of LNG, that such LNG does not comply with the LNG SPECIFICATIONS, OPERATOR shall be entitled

to cease unloading all or part of such LNG. In this case the PARTIES shall appoint an independent third party surveyor to verify the specifications of the affected LNG.

After the surveyor has confirmed that the LNG is OFF-SPECIFICATION LNG, OPERATOR shall issue a rejection notice and reject delivery of all or part of the OFF-SPECIFICATION LNG and in such case:

- (i) the LNG VESSEL shall be required to vacate the berth as soon as reasonable practicable;
 - (ii) CAPACITY USER shall have the sole responsibility for the disposal of any rejected LNG; and
 - (iii) subject to AA 15.5(d), CAPACITY USER shall protect, indemnify, defend and hold harmless OPERATOR in accordance with AA 12.3(d).
- (d) Subject to AA 15.5(d), CAPACITY USER shall protect, indemnify, defend and hold harmless OPERATOR for and against any direct costs, losses and expenses reasonably incurred by OPERATOR in the circumstances set forth in AAs 12.3(b)(iii) or (c)(iii), including but not limited to costs, losses and expenses resulting from damage to the RECEIVING FACILITY, and disposal of such OFF-SPECIFICATION LNG. OPERATOR shall, together with its claims under this AA 12.3(d), provide CAPACITY USER with all documentation which to the reasonable satisfaction of CAPACITY USER is sufficient to support or justify OPERATOR'S claims hereunder within ninety (90) days from the date on which such claims arose. If no such claim is made within the said ninety (90) day period CAPACITY USER shall be discharged and released from all liability in respect of any claims that OPERATOR may have under AAs 12.3(b)(iii) and (c)(iii).
- (e) OPERATOR'S right to be protected, indemnified, defended and held harmless in accordance with AA 12.3(d) as well as OPERATOR'S right to reject OFF-SPECIFICATION LNG, shall be OPERATOR'S sole and exclusive remedy against CAPACITY USER in respect of the delivery of OFF-SPECIFICATION LNG to OPERATOR.
- (f) Any LNG which was initially notified by OPERATOR as OFF-SPECIFICATION LNG but which then was later proven to not be OFF-SPECIFICATION LNG based on surveyor's report as per AA 12.3(c) shall be received by and delivered to the RECEIVING FACILITY by CAPACITY USER and OPERATOR shall, subject to AA 15.5(a), protect, indemnify, defend and hold harmless CAPACITY USER for any direct costs, losses and expenses reasonably by CAPACITY USER as a result of such LNG being notified as OFF-SPECIFICATION LNG .

12.4 **Refusal to Accept and/or Continue Loading OFF-SPECIFICATION LNG**

- (a) If any LNG loaded or scheduled to be loaded in accordance with this ACCESS ARRANGEMENT fails to, or in OPERATOR'S opinion is likely to not conform with the LNG SPECIFICATIONS, then as soon as reasonably practicable after OPERATOR becomes aware of the same, OPERATOR shall notify the

CAPACITY USER whose LNG VESSEL is being loaded, together with details of the reason for, and degree of such non-conformance.

- (b) If CAPACITY USER becomes aware before OPERATOR commences loading LNG, that such LNG will not comply with the LNG SPECIFICATIONS, CAPACITY USER shall be entitled to reject delivery of all or part of the OFF-SPECIFICATION LNG and in such case:
 - (i) OPERATOR shall be solely responsible for the disposal of any rejected LNG; and
 - (ii) subject to AA 15.5(b), OPERATOR shall protect, indemnify, defend and hold harmless CAPACITY USER in accordance with AA 12.4(d) only to the extent that the failure of such LNG to meet the LNG SPECIFICATION is attributable to the acts or omissions of OPERATOR and not attributable to the receipt by OPERATOR of OFF-SPECIFICATION LNG from (or on behalf of) another CAPACITY USER).
- (c) If CAPACITY USER becomes aware during the loading of LNG, that such LNG does not comply with the LNG SPECIFICATIONS, CAPACITY USER shall be entitled to cease unloading all or part of such LNG. In this case the PARTIES shall appoint an independent third party surveyor to verify the specifications of the affected LNG.

After surveyor has confirmed that the LNG is OFF-SPECIFICATION LNG, CAPACITY USER shall issue a rejection notice and reject delivery of all or part of the OFF-SPECIFICATION LNG and in such case:

- (i) the LNG VESSEL shall be required to vacate the berth as soon as reasonable practicable;
 - (ii) OPERATOR shall have the sole responsibility for the disposal of any rejected LNG; and
 - (iii) Subject AA 15.5(b), OPERATOR shall protect, indemnify, defend and hold harmless CAPACITY USER in accordance with AA 12.4(d) only to the extent that the failure of such LNG to meet the LNG SPECIFICATION is attributable to the acts or omissions of OPERATOR and not attributable to the receipt by OPERATOR of OFF-SPECIFICATION LNG from (or on behalf of) another CAPACITY USER).
- (d) Subject to AA 15.5(b), OPERATOR shall protect, indemnify, defend and hold harmless CAPACITY USER for and against any direct costs, losses and expenses reasonably incurred by CAPACITY USER in the circumstances set forth in AAs 12.4(b)(ii) or 12.4(c)(iii), including but not limited to costs, losses and expenses resulting from damage to the LNG VESSEL, and disposal of such OFF-SPECIFICATION LNG. CAPACITY USER shall, together with its claims under this AA 12.4(d), provide OPERATOR with all documentation which to the reasonable satisfaction of OPERATOR is sufficient to support or justify CAPACITY USER'S claims hereunder within ninety (90) days from the date on which such claims arose. If no such claim is made within the said ninety (90)

day period OPERATOR shall be discharged and released from all liability in respect of any claims that CAPACITY USER may have under AAs 12.4(b)(ii) or 12.4(c)(iii).

- (e) CAPACITY USER'S right to be protected, indemnified, defended and held harmless in accordance with AA 12.4(d), as well as CAPACITY USER'S right to reject OFF-SPECIFICATION LNG, shall be CAPACITY USER'S sole and exclusive remedy against OPERATOR in respect of the delivery of OFF-SPECIFICATION LNG to CAPACITY USER.
- (f) Any LNG which was initially notified by CAPACITY USER as OFF-SPECIFICATION LNG but which then was later proven to not be OFF-SPECIFICATION LNG based on surveyor's report as per AA 12.4(c) shall be received by and delivered to the LNG VESSEL by OPERATOR and CAPACITY USER shall, subject to AA 15.5(d), protect, indemnify, defend and hold harmless OPERATOR for any direct costs, losses and expenses reasonably incurred by OPERATOR as a result of such LNG being notified as OFF-SPECIFICATION LNG

12.5 **SEND OUT GAS Specification and Testing**

OPERATOR shall:

- (a) analyse the SEND OUT GAS delivered by OPERATOR to the NATURAL GAS DELIVERY POINT and shall ensure that such SEND OUT GAS shall comply with the SEND OUT GAS SPECIFICATIONS; and
- (b) provide in advance relevant information to CAPACITY USER regarding the anticipated quality of the SEND OUT GAS to be delivered pursuant to the TERMINAL USE AGREEMENT, including notification of SEND OUT GAS which is likely to not meet the SEND OUT GAS SPECIFICATIONS (which shall give details of the nature and expected magnitude of the variance).

12.6 CAPACITY USER shall have the right to request for SEND OUT GAS quantity and quality report from OPERATOR as and when reasonably requested.

12.7 **OFF-SPECIFICATION GAS procedure**

- (a) OPERATOR shall use its REASONABLE ENDEAVOURS to provide as soon as reasonably practicable in advance relevant information to CAPACITY USER regarding the quality, or any material change in the quality, of SEND OUT GAS to be made available for delivery by OPERATOR to CAPACITY USER pursuant to the TERMINAL USE AGREEMENT, including upon OPERATOR becoming aware that all or any part of the quantity of SEND OUT GAS which will be made available for delivery (or which has been delivered) does not comply with the SEND OUT GAS SPECIFICATIONS ("OFF-SPECIFICATION GAS"), provided, however, that OPERATOR shall not be liable to CAPACITY USER and will not be deemed in breach of the TERMINAL USE AGREEMENT for failure of the SEND OUT GAS to comply with the SEND OUT GAS SPECIFICATIONS that arises as a result of any quantity of LNG delivered to RECEIVING FACILITY by any CAPACITY USER being OFF-SPECIFICATION LNG.

- (b) Any notice issued pursuant to AA 12.7(a) shall detail such relevant failure (or such anticipated failure), the manner in, and extent to, which the OFF-SPECIFICATION GAS does not (or is likely not to) conform with the SEND OUT GAS SPECIFICATIONS, the reasons for such failure (or such anticipated failure) to conform (if then known) and OPERATOR'S bona fide estimate of the likely duration of such failure (or such anticipated failure).
- (c) OPERATOR shall use its REASONABLE ENDEAVOURS to carry out NATURAL GAS treatments (to the extent then available), including the injection of nitrogen and/or blending of LNG inventories to cause such OFF-SPECIFICATION GAS to comply with SEND OUT GAS SPECIFICATIONS. Any cost of such treatments shall be for the sole account of OPERATOR, except to the extent that the failure of such NATURAL GAS to meet the SEND OUT GAS SPECIFICATIONS is attributable to the receipt of OFF-SPECIFICATION LNG by OPERATOR from CAPACITY USER, in which case the cost of such treatments (including the cost of treating NATURAL GAS and/or LNG of other CAPACITY USERS that has been contaminated by CAPACITY USER'S OFF-SPECIFICATION LNG) or the flaring of any untreatable NATURAL GAS shall be for the sole account of the relevant CAPACITY USER.
- (d) If a notice is issued pursuant to AA 12.7(a) prior to the delivery of OFF-SPECIFICATION GAS, then CAPACITY USER shall notify OPERATOR as soon as reasonably practicable whether or not it is able to accept, or continue to accept, such OFF-SPECIFICATION GAS. CAPACITY USER will use REASONABLE ENDEAVOURS to accept any OFF-SPECIFICATION GAS.
- (e) If all CAPACITY USERS agree to accept delivery of OFF-SPECIFICATION GAS in accordance with AA 12.7(d), or if OPERATOR has received no objections from any CAPACITY USER within forty-eight (48) hours of sending the notice issued pursuant to AA 12.7(a), then OPERATOR shall be entitled to deliver such OFF-SPECIFICATION GAS and shall not be, or be deemed to be, in breach of any of its obligations under the TERMINAL USE AGREEMENT, or be otherwise liable to a CAPACITY USER, by virtue of its delivery of OFF-SPECIFICATION GAS.
- (f) If OFF-SPECIFICATION GAS is delivered to CAPACITY USER without CAPACITY USER being made aware that the NATURAL GAS is OFF-SPECIFICATION GAS, or the extent to which such NATURAL GAS is OFF-SPECIFICATION GAS, then only to the extent that the failure of such NATURAL GAS to meet the SEND OUT GAS SPECIFICATIONS is attributable to the acts or omissions of OPERATOR and not attributable to the receipt by OPERATOR of OFF-SPECIFICATION LNG from (or on behalf of) CAPACITY USER (in which case the relevant CAPACITY USER shall solely bear, and shall protect, indemnify, defend and hold harmless OPERATOR from and against, any and all claims by and liabilities associated with receipt of such OFF-SPECIFICATION LNG), OPERATOR, shall (subject to AA 15.5(a), protect, indemnify, defend and hold harmless CAPACITY USER in respect of direct costs, losses and expenses reasonably incurred (to the extent reasonable, actual, documented and direct) incurred by CAPACITY USER as a

consequence of the taking delivery or use of such OFF-SPECIFICATION GAS, subject to CAPACITY USER using REASONABLE ENDEAVOURS to minimise or eliminate such direct costs, losses and expenses.

(g) If CAPACITY USER takes delivery of any quantity of OFF-SPECIFICATION GAS, whether knowingly or unknowingly, under circumstances where OPERATOR is liable to CAPACITY USER, such CAPACITY USER'S right to seek any payments from OPERATOR under AA 12.7(f) shall be CAPACITY USER'S sole and exclusive remedy (in tort, including negligence, and contract) against OPERATOR for delivery by OPERATOR of such OFF-SPECIFICATION GAS.

(h) Disputes

Any DISPUTE between the PARTIES relating to the specification of any LNG or SEND OUT GAS is to be determined by an EXPERT in accordance with AA 37.0.

13.0 COMMINGLING, TITLE AND RISK

13.1 Title

- (a) Subject to AA 13.1(b), title to the LNG and NATURAL GAS shall not pass to OPERATOR at any time and shall remain with CAPACITY USER.
- (b) CAPACITY USER shall transfer to OPERATOR title to the IGC deducted from its LNG inventory pursuant to AA 10.3.
- (c) CAPACITY USER warrants to OPERATOR (for the benefit of OPERATOR and each other CAPACITY USER from time to time) that CAPACITY USER will have full title of ownership to all LNG unloaded at the LNG RECEIPT POINT by or on behalf of CAPACITY USER before commingling of that LNG with LNG owned by others takes place, in each case, free from any lien, charge or other encumbrance.
- (d) OPERATOR warrants that:
 - (i) NATURAL GAS delivered at the NATURAL GAS DELIVERY POINT; and
 - (ii) LNG delivered at the LNG RELOAD DELIVERY POINT by OPERATOR on behalf of CAPACITY USER,

will be free from any lien, charge or other encumbrance created by OPERATOR.

13.2 Custody and Risk

Other than in respect of IGC:

- (a) Custody of and risk of loss of the LNG will pass from CAPACITY USER to OPERATOR at the LNG RECEIPT POINT;

- (b) Custody of and risk of loss of the NATURAL GAS will pass from OPERATOR to CAPACITY USER at the NATURAL GAS DELIVERY POINT; and
- (c) Custody of and risk of loss of LNG will pass from OPERATOR to CAPACITY USER at the LNG RELOAD DELIVERY POINT,

provided that OPERATOR shall not be liable for any loss or damage to CAPACITY USER'S LNG and/or NATURAL GAS except to the extent that such loss or damage arises from act or omission of OPERATOR in which case OPERATOR'S liability shall be capped at Malaysian Ringgit (RM 1,000,000) per year per CAPACITY USER.

13.3 Commingling

OPERATOR shall have the absolute right to commingle CAPACITY USER'S LNG and SEND OUT GAS with other CAPACITY USERS' LNG and SEND OUT GAS.

14.0 UNDERTAKINGS

14.1 Standard of Performance

In performing its obligations and exercising its rights under this ACCESS ARRANGEMENT, each PARTY shall act in accordance with APPLICABLE LAWS, AUTHORISATIONS, INTERNATIONAL LNG VESSEL STANDARDS (in the case of CAPACITY USER), INTERNATIONAL LNG TERMINAL STANDARDS (in the case of OPERATOR) and the standards of a REASONABLE AND PRUDENT OPERATOR.

14.2 Authorisations

Each PARTY shall, subject to the remaining provisions of this ACCESS ARRANGEMENT, obtain, comply with and do all that is necessary to maintain in full force any AUTHORISATIONS required under any APPLICABLE LAWS as and when such AUTHORISATIONS are required to enable it to comply with its obligations under this ACCESS ARRANGEMENT.

15.0 LIABILITIES AND INDEMNITIES

15.1 Damage to the RECEIVING FACILITY

OPERATOR shall protect, indemnify, defend and hold harmless CAPACITY USER against any claim arising out of loss or damage to the RECEIVING FACILITY, except to the extent that such loss or damage arises from the WILFUL MISCONDUCT or GROSS NEGLIGENCE of CAPACITY USER.

15.2 Damage to LNG VESSELS

CAPACITY USER will protect, indemnify, defend and hold harmless OPERATOR against any claim arising out of loss or damage to an LNG VESSEL except to the extent that such loss or damage arises from the WILFUL MISCONDUCT or GROSS NEGLIGENCE of OPERATOR.

15.3 Personal Injury and Death

Each PARTY hereby agrees to protect, indemnify, defend and hold harmless the other PARTY and the other PARTY'S AFFILIATES, employees, officers, directors and agents for and against any direct costs, losses and expenses reasonably incurred in respect of injury, death, sickness or ill-health caused to or suffered by the indemnifying PARTY'S employees, officers, directors and agents directly as a result of, or arising out of or in connection with the performance or non-performance of this ACCESS ARRANGEMENT or the operations or activities in relation to the RECEIVING FACILITY or the LNG VESSEL regardless of the cause or reason therefor except to the extent that such loss or damage arises from the WILFUL MISCONDUCT or GROSS NEGLIGENCE of the indemnified PARTY.

15.4 **Third Party Claims**

Subject to the express provisions of this ACCESS ARRANGEMENT, each PARTY hereby agrees that neither PARTY shall be obliged to protect, indemnify, defend or hold harmless the other PARTY from or against any third party claims. Liability for such third party claims shall be as determined by law.

15.5 **Cap on OPERATOR'S and CAPACITY USER'S liability**

- (a) Subject to AA 15.5(c), OPERATOR'S aggregate liability to CAPACITY USER in respect of a single occurrence or series of occurrences under AAs 4.2, 7.11(n), 8.3(i), 8.4(b), 12.3(f), and 12.7(f) shall be subject to a cap equal to the amount of the daily REGASIFICATION FEE multiplied by the number of days during which such occurrence or series of occurrences occurs.
- (b) OPERATOR'S aggregate liability to any CAPACITY USER in respect of a single occurrence or series of occurrences under AAs 8.3(i), 8.4(b), 12.4(b)(ii), 12.4(c)(iii) and AA 12.4(d) shall be subject to a cap equal to the amount of the daily RELOAD FEE multiplied by the number of days during which such occurrence or series of occurrences occurs.
- (c) To the extent that OPERATOR'S liability under AA 7.11(n) or 8.4(b) is caused by a failure of the counterparty under the JETTY USAGE AGREEMENT and OPERATOR has used REASONABLE ENDEAVOURS to mitigate the effects of such failure:
 - (i) OPERATOR shall use REASONABLE ENDEAVOURS to recover any liability owed to OPERATOR under the terms of the JETTY USAGE AGREEMENT;
 - (ii) OPERATOR'S liability to any CAPACITY USER shall be limited to that CAPACITY USER'S pro rata share of the damages recovered by OPERATOR under AA 15.5(c)(i) above; and
 - (iii) CAPACITY USERS are not relieved of any obligation to pay the applicable FEE in accordance with the terms of this ACCESS ARRANGEMENT.
- (d) Any CAPACITY USER'S aggregate liability to OPERATOR in respect of a single occurrence or series of occurrences under AAs 7.12(f), 12.3(b)(iii), 12.3(c)(iii), 12.3(d) and 12.4(f) shall be subject to a cap equal to the amount of

the daily REGASIFICATION FEE multiplied by the number of days over which such occurrence or series of occurrences occurs.

- (e) The limitations on liability of a PARTY set out in this AA 15.5 shall not apply in the case of WILFUL MISCONDUCT or GROSS NEGLIGENCE of that PARTY or its personnel charged with supervision of the performance by that PARTY of this AA.

15.6 **Exclusive Remedies**

The PARTIES intend that their respective rights, obligations and liabilities as provided for in this ACCESS ARRANGEMENT shall be exhaustive of the rights, obligations and liabilities of each of them to the other arising out of, under or in connection with the subject matter of this ACCESS ARRANGEMENT. Accordingly, the remedies expressly stated in this ACCESS ARRANGEMENT are intended to be the sole and exclusive remedies of the PARTIES to this ACCESS ARRANGEMENT for the liabilities of the PARTIES arising out of or in connection with the subject matter of this ACCESS ARRANGEMENT, notwithstanding any remedy otherwise available at law or in equity.

15.7 **Exclusion of Consequential Loss**

Neither PARTY shall be liable to the other for or in respect of:

- (a) loss of profits, loss of revenue, loss of use, loss of contracts, or loss of business opportunity; or
- (b) any indirect or consequential loss or damage; or
- (c) any special, incidental, exemplary or punitive damages,

suffered or incurred by the other PARTY or any person resulting from breach of or failure to perform the TERMINAL USE AGREEMENT or the breach of any representation or warranty hereunder, whether express or implied, and whether such damages are claimed under breach of warranty, breach of contract, tort or other theory or course of action at law or in equity.

16.0 **INTERNAL GAS CONSUMPTION**

16.1 OPERATOR shall be responsible for procuring at the LNG TERMINAL FACILITY at no cost to CAPACITY USER a volume of LNG and/or NATURAL GAS equal to the aggregate of:

- (a) ANTICIPATED IGC; and
- (b) UNACCOUNTED GAS in excess of the ANTICIPATED IGC.

16.2 CAPACITY USER shall bear by way of deduction from its LNG inventory pursuant to AA 10.3:

- (a) LOST GAS that is consumed, lost and/or unaccounted for due to the acts or omissions of CAPACITY USER; and
 - (b) its pro rata share of LOST GAS in excess of ANTICIPATED IGC that is consumed, lost and/or unaccounted for due to the acts or omissions of neither OPERATOR nor any CAPACITY USER (calculated on the basis of such CAPACITY USER'S REGASIFICATION SERVICES ENTITLEMENT expressed as a proportion of the aggregate of all CAPACITY USERS' REGASIFICATION SERVICES ENTITLEMENT).
- 16.3 If, on any GAS DAY, as a result of the exercise by OPERATOR of its rights under AA 7.11(l)(i), SEND OUT GAS is delivered from the RECEIVING FACILITY at a rate less than the MINIMUM SEND OUT RATE, CAPACITY USER'S share of the INTERNAL GAS CONSUMPTION for such GAS DAY shall be calculated in the manner provided in Schedule 6.

17.0 INVOICING, PAYMENTS, TAXES AND DUTIES

- 17.1 OPERATOR shall submit invoices at the end of each CONTRACT MONTH to CAPACITY USER for the SERVICES provided during that CONTRACT MONTH. Such invoice shall be for actual SERVICES provided for the first twenty five (25) days of the CONTRACT MONTH and for estimated SERVICES provided for the remainder of the CONTRACT MONTH and shall contain in respect of the CONTRACT MONTH at least the following:
- (a) the REGASIFICATION FEE, the STORAGE FEE and the RELOAD FEE each in United States Dollars respectively; and
 - (b) the number of hours for which the RECEIVING FACILITY is UNAVAILABLE during such CONTRACT MONTH.
- 17.2 Payment shall be made in full by CAPACITY USER in United States Dollars in accordance with AA 17.1 to the bank account as designated by OPERATOR within thirty (30) days from the date of receipt of an invoice. In the event that settlement of such amount is required by the APPLICABLE LAWS to be made in Malaysian Ringgit, OPERATOR shall issue the invoice in respect of such amount in the Malaysian Ringgit equivalent of such United States Dollars amount, which Malaysian Ringgit equivalent shall be determined by OPERATOR by applying the closing mid-rate for United States Dollars to Malaysian Ringgit as published by Reuters at 0900 hours on the invoice date.
- 17.3 Any adjustments to the invoices pursuant to AA 17.1, in relation to the actual SERVICES provided for the remainder of the CONTRACT MONTH estimated pursuant to AA 17.1, shall be reflected in an additional invoice issued in the first ten (10) days of the following CONTRACT MONTH by OPERATOR and be payable in accordance with AA 17.2. Any other adjustment to an invoice shall be through issuance of debit and credit notes.
- 17.4 Promptly following the end of the TERM, OPERATOR shall submit an invoice to CAPACITY USER in any remaining amount due to OPERATOR for SERVICES provided (including as a result of any difference between the SERVICES actually

provided since the date of the previous invoice and the SERVICES estimated to be provided in the previous invoice). Such invoice shall be payable in accordance with AA 17.2.

17.5 Prior to initiating a DISPUTE relating to an invoice, a credit note or a debit note, payment by CAPACITY USER or OPERATOR, as the case may be, on an invoice, a credit note or a debit note shall be made in full. After such payment has been made, the PARTY intending to initiate a DISPUTE must notify the other PARTY that it is disputing an invoice, a credit note or a debit note by specifying:

- (a) the date and number of the invoice, credit note or debit note;
- (b) the items under DISPUTE;
- (c) the basis of DISPUTE; and
- (d) the amount of money related to the DISPUTE.

All notifications of DISPUTE relating to an invoice, a debit note or a credit note shall be issued within thirty (30) days from the date of invoice, credit note or debit note, failing which such right is deemed waived.

17.6 The PARTIES may agree to submit disputes over invoicing either for determination by an EXPERT under AA 37.0 or to the DISPUTE RESOLUTION COMMITTEE under AA 38.1. Where the PARTIES cannot agree on either of the above alternatives then the dispute shall be submitted to arbitration under AA 38.2 to 38.9.

17.7 Interest on any amount due but not paid on the due date shall accrue from the day immediately following the due date up to and including the day when payment is made, at a rate per annum which shall be three per cent (2%) above the average of the quoted six (6) month London Interbank Offered Rate ("LIBOR") computed on the basis of a three hundred and sixty (360) day year of twelve (12) thirty (30) day months compounded monthly, as most recently published by Reuters on the due date. If no such interest rate is published on that day, the interest rate published on the next preceding day on which such a rate was so published shall be used.

17.8 All payments shall be inclusive of taxes, duties, and levies of a similar nature imposed by any GOVERNMENTAL AUTHORITY with respect to the SERVICES.

17.9 The PARTIES hereby represent that, to the best of their knowledge and belief, the above payments and payment procedures do not violate any APPLICABLE LAWS or regulations including, without limitation, tax or exchange control laws or regulations. If it is later determined that these payments/procedures do violate any APPLICABLE LAWS or regulation, the PARTIES will change them to comply with such law/regulation, but still implement the intent expressed in this clause to the maximum extent possible.

17.10 Taxes

- (a) Each PARTY shall be responsible for and shall pay at its own expense when due and payable all TAXES assessed against it in connection with the ACCESS

ARRANGEMENT. All TAXES levied on each PARTY shall be for the account of the PARTY and shall not be reimbursed by the other PARTY.

- (b) Each PARTY shall protect, indemnify and hold safe and harmless the other PARTY from any and all claims or liability for TAXES assessed or levied by the Inland Revenue Board of Malaysia ("IRB"), whichever is applicable against such PARTY or its contractors for or on account of any payment made to or earned by the PARTY in connection with this ACCESS ARRANGEMENT.

Each PARTY further shall protect, indemnify and hold the other party harmless from all TAXES assessed or levied against or on account of wages, salaries or other benefits paid to or enjoyed by such PARTY's employees, or employees of its contractors, and all TAXES assessed or levied against, on or for account of any property or equipment of such PARTY.

- (c) Each PARTY shall have the right to withhold TAXES from payments due to the other PARTY under this ACCESS ARRANGEMENT to the extent that such withholding may be required by the IRB or relevant tax authorities, and payment by such PARTY to the IRB or relevant tax authorities of the amount of money so withheld will relieve the other PARTY from any further obligation to the other PARTY with respect to the amount so withheld.
- (d) Each PARTY shall indemnify the other PARTY against all claims, demands and causes of action based on any actual TAXES for which such PARTY is liable or any actual or alleged failures by such PARTY or its contractors to comply with applicable tax reporting, return, or other procedural requirement with respect to this ACCESS ARRANGEMENT. The indemnity shall include without limitation, all penalties, awards, and judgments; court and arbitration costs; legal fees; and other reasonable expenses associated with such claims, demands, and causes of action.
- (e) Each PARTY shall give prompt notice to the other PARTY of all matters pertaining to non-payment, payment under protest or claim for immunity or exemption from any TAXES.

In the event that a refund opportunity arises with respect to any TAX paid by one PARTY as a result of the transactions governed by this ACCESS ARRANGEMENT, both PARTIES shall reasonably work together to pursue such refund. If one PARTY receives a refund or a credit for any TAX paid by the other PARTY with respect to this ACCESS ARRANGEMENT, then the PARTY receiving the refund or credit agrees to refund to that other PARTY the full amount of such refund or credit.

17.11 Service Tax

- (a) This Clause shall only apply upon the enactment and implementation date of the Service Tax Act 2018 in Malaysia.
- (b) Where service tax is applicable to any services rendered by the OPERATOR under the AGREEMENT, CUSTOMER shall be responsible for and pay the service tax when invoiced by the OPERATOR for any taxable service rendered, provided that OPERATOR shall provide CUSTOMER a copy of valid Service

Tax license issued by the Royal Malaysian Customs Department (“Customs Authority”) confirming that OPERATOR is licensed under the applicable Act as a taxable person providing taxable services.

- (c) Service tax amount shall be separately stated in the prices and/or rates, and shall be separately itemized in the invoice.
- (d) For avoidance of doubt, “Service Tax” as mentioned above refers to the tax imposed on taxable services provided by taxable person in Malaysia effective from 1 September 2018 as set out in the Service Tax Act 2018.

17.12 Costs and Expenses

Each PARTY shall bear its own respective legal costs, disbursements, charges and expenses incurred in connection with the negotiation, preparation and execution of the TERMINAL USE AGREEMENT, but the stamp duty shall be borne by CAPACITY USER.

18.0 CREDIT SUPPORT

CAPACITY USER shall at all times meet the credit requirements as set out further in Schedule 10.

19.0 SUSPENSION

19.1 OPERATOR shall have the right (but is not obligated to) to suspend the SERVICES if CAPACITY USER:

- (a) fails to pay in full any amount when due, including any invoice issued by OPERATOR in respect of the FEE pursuant to AA 17.0; or
- (b) fails to comply with AA 18.0

(each a "SUSPENSION EVENT"), in accordance with this AA 19.0

19.2 Upon the occurrence of a SUSPENSION EVENT, OPERATOR may give written notice to CAPACITY USER requiring CAPACITY USER to remedy the default within fourteen (14) days from the date of such notice. If CAPACITY USER fails to remedy the SUSPENSION EVENT within the period specified, OPERATOR may, without any liability on the part of OPERATOR, suspend the SERVICES with immediate effect by giving notice of such suspension. Such SERVICES will remain suspended until CAPACITY USER remedies the SUSPENSION EVENT, in which case the SERVICES will be resumed.

19.3 CAPACITY USER agrees to protect, indemnify, defend and hold harmless OPERATOR for and against any direct costs, losses or expenses reasonably incurred by OPERATOR as a result of the SERVICES being suspended pursuant to this AA 19.0.

20.0 TERMINATION

- 20.1 Subject to this AA 20.0, CAPACITY USER shall have the right to terminate the TERMINAL USE AGREEMENT if any of the following (each an "OPERATOR EVENT OF DEFAULT") occur:
- (a) an INSOLVENCY EVENT occurs in relation to OPERATOR; or
 - (b) OPERATOR fails to perform any of its material obligations under the TERMINAL USE AGREEMENT and such failure causes the RECEIVING FACILITY to be UNAVAILABLE for a period in excess of 365 days in any period of 1095 consecutive days.
- 20.2 Subject to this AA 20.0, OPERATOR shall have the right to terminate the TERMINAL USE AGREEMENT if any of the following (each a "CAPACITY USER EVENT OF DEFAULT") occur:
- (a) CAPACITY USER fails to pay when due any invoice issued by OPERATOR in respect of the FEE pursuant to AA 17.0; or
 - (b) CAPACITY USER fails to pay OPERATOR any amount owing to OPERATOR under the TERMINAL USE AGREEMENT (other than the FEE); or
 - (c) if CAPACITY USER is a shipping licensee, CAPACITY USER loses its shipping licence; or
 - (d) OPERATOR elects to terminate the TERMINAL USE AGREEMENT pursuant to paragraph 2.6 of Schedule 10; or
 - (e) the JETTY USAGE AGREEMENT is terminated; or
 - (f) OPERATOR serves a request or notice pursuant to clauses 6.2.1(b) or 6.2.2(c) of the INTER-CAPACITY USER AGREEMENT relating to a default or non-payment by CAPACITY USER; or
 - (g) an INSOLVENCY EVENT occurs in relation to CAPACITY USER; or
 - (h) OPERATOR becomes entitled to terminate the TERMINAL USE AGREEMENT pursuant to AA 41.2(d) or 41.3(e).
- 20.3 Upon the occurrence of an OPERATOR EVENT OF DEFAULT or CAPACITY USER EVENT OF DEFAULT, the non-defaulting PARTY may give written notice ("DEFAULT NOTICE") to the defaulting PARTY specifying OPERATOR EVENT OF DEFAULT or CAPACITY USER EVENT OF DEFAULT (as the case may be).
- 20.4 If CAPACITY USER fails to cure a CAPACITY USER EVENT OF DEFAULT under AA 20.2(a), 20.2(b), 20.2(c) or 20.2(d) within fifteen (15) days of the DEFAULT NOTICE, OPERATOR may terminate the TERMINAL USE AGREEMENT with immediate effect by giving notice of such termination.
- 20.5 If an OPERATOR EVENT OF DEFAULT occurs under AA 20.1(a) or 20.1(b) or a CAPACITY USER EVENT OF DEFAULT under AA 20.2(e), 20.2(f), 20.2(g) or 20.2(h), the non-defaulting PARTY may terminate the TERMINAL USE AGREEMENT with

immediate effect on notice at any time on or following service of the DEFAULT NOTICE.

- 20.6 Either PARTY may terminate the TERMINAL USE AGREEMENT by providing thirty (30) days' prior written notice to OPERATOR if any EVENT OF FORCE MAJEURE is continuing for a period of three hundred and sixty (360) consecutive calendar days
- 20.7 On termination of the TERMINAL USE AGREEMENT pursuant to this AA 20.0 all the rights and obligations of the PARTIES under the TERMINAL USE AGREEMENT shall cease to have effect PROVIDED that such termination shall not affect:
- (a) any right and obligation of the PARTIES expressed to arise under the TERMINAL USE AGREEMENT on, or to survive, the termination thereof; and
 - (b) any liability of either PARTY accrued prior to the date of termination.
- 20.8 Following termination of the TERMINAL USE AGREEMENT for a CAPACITY USER EVENT OF DEFAULT, CAPACITY USER shall remain obliged to pay the FEE as if the TERMINAL USE AGREEMENT had not been terminated until the date on which the TERMINAL USE AGREEMENT would have expired in accordance with its terms, provided that the amount payable under this AA 20.8 will be reduced by any FEE paid by a new CAPACITY USER who receives SERVICES pursuant to a replacement TERMINAL USE AGREEMENT (and where more than one TERMINAL USE AGREEMENT is terminated for CAPACITY USER EVENT OF DEFAULT, any new TERMINAL USE AGREEMENT shall be deemed to replace the terminated TERMINAL USE AGREEMENT in the chronological order in which the latter was terminated).
- 20.9 In the event of termination of the TERMINAL USE AGREEMENT for OPERATOR EVENT OF DEFAULT pursuant to this AA 20.0 the PARTIES shall meet to discuss appropriate alternative arrangements. If no such arrangements have been agreed by the PARTIES by the date falling three (3) months after the date of termination of the TERMINAL USE AGREEMENT, the liability of OPERATOR arising as a result of termination shall be determined in accordance with Malaysian law.
- 20.10 Neither PARTY shall have any liability as a result of termination of TERMINAL USE AGREEMENT pursuant to AA 20.6.

21.0 CHANGE OF LAW

If there is a change in APPLICABLE LAWS after the SERVICE COMMENCEMENT DATE which (i) makes it impossible for a PARTY to fulfil all or part of its obligations under the TERMINAL USE AGREEMENT or (ii) has a material adverse effect on the ability of a PARTY to fulfil any of its obligations under the TERMINAL USE AGREEMENT, or (iii) makes all or any part of the TERMINAL USE AGREEMENT unenforceable, then upon the written request of any PARTY, the PARTIES shall promptly meet and discuss and, acting in good faith, agree upon any amendments that may be required to the terms of the TERMINAL USE AGREEMENT in order to take into account of the change in APPLICABLE LAWS such that each PARTY can continue to comply with the terms of the TERMINAL USE AGREEMENT.

22.0 FORCE MAJEURE

22.1 Definition of EVENT OF FORCE MAJEURE

For the purposes of the TERMINAL USE AGREEMENT, ("EVENT OF FORCE MAJEURE") means any occurrence or circumstance beyond the control of the PARTY claiming to be excused from its obligations by virtue of such occurrence or circumstance ("AFFECTED PARTY") and resulting in or causing a failure by the AFFECTED PARTY in the fulfilment of any of its obligations to the other PARTY and which by the exercise of due diligence the AFFECTED PARTY is unable to prevent or overcome and without prejudice to the generality of the foregoing includes:

- (a) fire, haze, explosion and acts of God including tsunami, flood, lightning, storm, typhoon, hurricane, tornado, cyclone, earthquake, landslide, perils at sea, soil erosion, subsidence, washout or epidemic (excluding ADVERSE WEATHER CONDITIONS); or
- (b) war (whether declared or undeclared), civil war, act of terrorism, piracy, riot, civil disturbance, blockade, insurrection, embargo, trade sanctions, military uprising or act of public enemy; or
- (c) strike, lock out or industrial disturbance, provided that any strike, lock out or industrial disturbance that affects OPERATOR or OPERATOR'S sub-contractors only, will not be considered an EVENT OF FORCE MAJEURE; or
- (d) loss of, damage to, or failure of the RECEIVING FACILITY (including damage due to LNG VESSEL collision with the RECEIVING FACILITY and with other vessels); or
- (e) changes in APPLICABLE LAWS that directly affect any of the PARTIES and/ or render unlawful performance of any of the PARTIES' obligations hereunder; or
- (f) inability of any CAPACITY USER'S customers to take NATURAL GAS if such customer's inability is occasioned by an event or occurrence of the character described or envisaged in this provision as constituting an EVENT OF FORCE MAJEURE; or
- (g) loss of, damage to, or unavailability of the PGU NETWORK; or
- (h) acts of any GOVERNMENTAL AUTHORITY, including any exercise of the ENERGY COMMISSION'S authority under section 38 of the GAS SUPPLY ACT; or
- (i) an event of force majeure under the terms of the JETTY USE AGREEMENT; or
- (j) reduction or interruption in electricity supplies affecting the RECEIVING FACILITY.

22.2 Effect of EVENT OF FORCE MAJEURE

- (a) Without prejudice to any other provisions of the TERMINAL USE AGREEMENT limiting or restricting the liability of the AFFECTED PARTY, if by reason of an EVENT OF FORCE MAJEURE, the AFFECTED PARTY is rendered unable wholly or in part to carry out its obligations under the TERMINAL USE AGREEMENT, then:
 - (i) its obligations will be suspended to the extent the AFFECTED PARTY'S ability to perform is hindered by the EVENT OF FORCE MAJEURE; and
 - (ii) the failure or omission of the AFFECTED PARTY to perform such obligations will not be treated as a failure or omission to comply with the TERMINAL USE AGREEMENT.
- (b) Where OPERATOR or CAPACITY USER fails or omits to perform an obligation under the TERMINAL USE AGREEMENT in obedience to any Government act, order or regulation, provided that it is proved that such failure or omission is the necessary consequence of such act, order or regulation, such failure or omission shall not be treated as a failure or omission to comply with the TERMINAL USE AGREEMENT.
- (c) If OPERATOR is unable to meet its obligations to CAPACITY USER under this ACCESS ARRANGEMENT due to an EVENT OF FORCE MAJEURE that affects the berthing of LNG VESSELS and the receipt of LNG, then OPERATOR shall cancel the BERTHING SLOTS reflected in the issued ANNUAL OPERATION SCHEDULE or the THREE MONTH OPERATION SCHEDULE.

22.3 No Relief

- (a) Notwithstanding the provisions of AA 22.2, CAPACITY USER shall not be obliged to pay the FEES to the extent that OPERATOR is not providing the SERVICES as a result of an EVENT OF FORCE MAJEURE.
- (b) Subject to AA 22.3(a), an EVENT OF FORCE MAJEURE will not relieve a PARTY from any liability or obligation to:
 - (i) make payments due under the TERMINAL USE AGREEMENT; or
 - (ii) give any notice due under the TERMINAL USE AGREEMENT.

22.4 Notification of EVENT OF FORCE MAJEURE

Following any occurrence of an EVENT OF FORCE MAJEURE, the AFFECTED PARTY must, as soon as reasonably practicable, notify the other PARTY of the occurrence and nature of the EVENT OF FORCE MAJEURE, the expected duration thereof, (insofar as the same can reasonably be assessed), and the obligations of the AFFECTED PARTY performance of which is affected by it and from time to time thereafter provide to the other PARTY reasonable details of:

- (a) the estimated period during which performance may be prevented, interfered with, delayed, including, to the extent known or ascertainable, the estimated extent of such reduction in performance;

- (b) the particulars of the programme to be implemented to resume normal performance hereunder; and
- (c) the anticipated portion of the SERVICES that will not be made available or received, as the case may be, by reason of and EVENT OF FORCE MAJEURE.

Such notices shall thereafter be updated at reasonable intervals during the period of such claimed EVENT OF FORCE MAJEURE specifying the actions being taken to remedy the circumstances causing such EVENT OF FORCE MAJEURE.

22.5 Resumption of Obligations

The AFFECTED PARTY must resume the performance of any of its obligations that are affected by an EVENT OF FORCE MAJEURE as soon as reasonably practicable after the removal of the cause of the failure and must notify the other PARTY prior to its resumption.

22.6 Termination for EVENT OF FORCE MAJEURE

Without prejudice to the preceding paragraphs, if any EVENT OF FORCE MAJEURE is continuing for a period of three hundred and sixty (360) consecutive days CAPACITY USER shall be entitled to terminate the TERMINAL USE AGREEMENT and AA 20.6 shall apply.

23.0 INSURANCE

23.1 OPERATOR'S obligation to INSURE

Without prejudice to OPERATOR'S liability and responsibility as contained elsewhere in the TERMINAL USE AGREEMENT, OPERATOR shall procure, and maintain at its own cost and expense during the TERM, the following insurances applicable to its operations with respect to the TERMINAL USE AGREEMENT:

- (a) Workmen's Compensation Insurance and/or Employer's Liability Insurance and/or any other insurance with statutory limits as required by the laws of Malaysia to provide for payment to its employees employed on or in connection with the SERVICES covered by this OPERATOR and/or their dependants;
- (b) Motor Vehicle Liability Insurance for owned, non-owned and hired units covering the use of such vehicles in accordance with the Road Transport Act;
- (c) "All Risks" Physical Damage Insurance to cover the full replacement value of OPERATOR'S equipment used, owned, leased or hired by OPERATOR;
- (d) Comprehensive General Liability Insurance; and
- (e) any other insurance which may be relevant and/or which may be required by APPLICABLE LAWS.

23.2 CAPACITY USER'S OBLIGATION TO INSURE

Without prejudice to CAPACITY USER's liability and responsibility as contained elsewhere in the TERMINAL USE AGREEMENT, CAPACITY USER shall procure,

and maintain at its own cost and expense during the TERM, the following insurances applicable to its operations with respect to the TERMINAL USE AGREEMENT:

- (a) Protection and Indemnity Insurance for owned, non-owned or hired waterborne craft covering CAPACITY USER'S liability including but not limited to crew, pollution, contractual and wreck arising from the use and/or operation of the said craft;
- (b) Hull and Machinery insurance for all vessels owned, hired, chartered, leased or used by CAPACITY USER, in connection with the SERVICES for an amount of not less than the full replacement value of each such vessel, including cover for full collision liability and the cost of removal of debris; and
- (c) Any other insurance which may be relevant and/or which may be required by APPLICABLE LAWS.

23.3 Notwithstanding the above, the provision of all insurances shall not limit or reduce either PARTY'S liability or responsibility under the TERMINAL USE AGREEMENT.

23.4 Each PARTY shall include a waiver of all express or implied rights of subrogation against the other PARTY in the terms of all insurances it is required to obtain and maintain pursuant to the TERMINAL USE AGREEMENT.

24.0 CONFIDENTIALITY

24.1 Each PARTY hereto undertakes that it will not, save as permitted pursuant to AA 24.2, divulge any CONFIDENTIAL INFORMATION to any persons other than its own officers, employees or professional advisers as having a reasonable need for such information in carrying out their respective duties for the purpose of the TERMINAL USE AGREEMENT and will procure that such persons will not disclose such information save as aforesaid.

24.2 Notwithstanding AA 24.1, either PARTY shall have the right to disclose CONFIDENTIAL INFORMATION without obtaining the other PARTY'S prior consent in the following situations:

- (a) if required by any court of law or any law, rule or regulation, or by a GOVERNMENTAL AUTHORITY (including by the ENERGY COMMISSION having or asserting jurisdiction over a PARTY such disclosure in accordance with that jurisdiction (including in connection with the resolution of a DISPUTE), or pursuant to the rules of Bursa Malaysia Securities Berhad (Bursa Malaysia), Securities Commission (SC) or any other recognised stock exchange or agency on which either PARTY'S securities are quoted;
- (b) to accountants, other professional consultants or insurers, provided such disclosure is solely to assist the purpose for which the aforesaid were so engaged and further provided that such persons agree to hold such information or documents under terms of confidentiality equivalent to AA 24.0;
- (c) to its AFFILIATES and its shareholders, provided that such recipient entity has a bona fide business need for such information and agrees to hold such information or documents under terms of confidentiality equivalent to AA 24.0;

- (d) to any GOVERNMENT AL AUTHORITIES to the extent such disclosure assists OPERATOR and CAPACITY USER in obtaining approvals;
 - (e) to an EXPERT or to an arbitral tribunal in connection with the resolution of a DISPUTE; and
 - (f) to the extent any such information or document has entered the public domain other than through the fault or negligence of the PARTY making the disclosure.
- 24.3 The obligations in AAs 24.1 and 24.2 with regard to the CONFIDENTIAL INFORMATION shall remain in effect for three (3) years after the TERMINAL USE AGREEMENT is terminated or expires.
- 24.4 Subject to any applicable statutory or regulatory rules or otherwise as may be required by Bursa Malaysia or SC, none of the PARTIES hereto shall make any public announcement in relation to the terms of the TERMINAL USE AGREEMENT of the transactions or arrangements hereby contemplated or herein referred to or any matter ancillary hereto unless:
- (a) the purpose, form and text thereof shall be specifically agreed in writing by the other PARTY; or
 - (b) if the same shall be required by Bursa Malaysia or SC, the PARTIES shall mutually consult on the proposed text thereof and use all REASONABLE ENDEAVOURS to agree upon such text.

25.0 NOTICES

- 25.1 Except as otherwise specifically provided, all notices, statements, invoices, payments, requests, demands, or other communications under the TERMINAL USE AGREEMENT shall be in writing or by facsimile in English sent or delivered to the intended recipient PARTY at the address indicated by the recipient PARTY.
- 25.2 All communications between the PARTIES shall be effective, in the case of written communication when delivered and, in case of a communication by facsimile, when sent and addressed as set forth above.
- 25.3 Oral communication is not notice for any purposes of the TERMINAL USE AGREEMENT, and telephone numbers for the PARTIES are listed as a matter of convenience only. Regarding facsimile and/or e-mail communication automatic delivery receipts issued is not evidenced of effective notices for purposes of the TERMINAL USE AGREEMENT and shall only be effective following direct human acknowledgement.

26.0 ASSIGNMENT AND SERVICES TRANSFER

26.1 Transfer by OPERATOR

Subject to AA 26.2, OPERATOR shall not assign, convey, transfer or otherwise dispose of any part of or all of its rights and/or obligations under the TERMINAL USE AGREEMENT to any person or entity without the prior written consent of CAPACITY USER.

26.2 OPERATOR may:

- (a) assign, convey, transfer or otherwise dispose of any part of or all of its rights and/or obligations under the TERMINAL USE AGREEMENT to an AFFILIATE; or
- (b) assign its rights under the TERMINAL USE AGREEMENT to any person providing finance to OPERATOR or any agent of such person provided that such assignment shall not modify or amend any of CAPACITY USER'S rights and OPERATOR'S obligations under the TERMINAL USE AGREEMENT.

26.3 **ENTIRE SERVICE TRANSFER by a CAPACITY USER**

CAPACITY USER may assign, convey, transfer, or otherwise dispose of all of its rights and obligations under the TERMINAL USE AGREEMENT to any person that meets the ACCESS REQUIREMENTS in accordance with AA 2.1 (a "PROPOSED TRANSFEREE") for the duration of the TERM (an "ENTIRE SERVICE TRANSFER"), subject to the following:

- (a) CAPACITY USER and the PROPOSED TRANSFEREE must jointly deliver to OPERATOR notice of their intention to effect such ENTIRE SERVICE TRANSFER no later than thirty (30) days before the proposed ENTIRE SERVICE TRANSFER EFFECTIVE TIME;
- (b) OPERATOR providing written confirmation to CAPACITY USER and PROPOSED TRANSFEREE that OPERATOR consents to such ENTIRE SERVICE TRANSFER (following OPERATOR'S receipt of a valid transfer notice in accordance with AA 26.3(a)), such consent to not be unreasonably withheld or delayed; and
- (c) an effective ENTIRE SERVICE TRANSFER having taken place in accordance with AA 26.4.

26.4 An ENTIRE SERVICE TRANSFER pursuant to AA 26.3 shall take effect at the time at which a novation agreement substantially in the form attached in Schedule 11 entered into between OPERATOR, the transferring CAPACITY USER and the PROPOSED TRANSFEREE comes into effect in accordance with its terms (the "ENTIRE SERVICE TRANSFER EFFECTIVE TIME").

26.5 Subject to an effective ENTIRE SERVICE TRANSFER having taken place in accordance with AA 26.4, with effect from the ENTIRE SERVICE TRANSFER EFFECTIVE TIME, OPERATOR acknowledges that the PROPOSED TRANSFEREE may exercise all rights, and will assume all liabilities and obligations, of CAPACITY USER under the TERMINAL USE AGREEMENT in substitution for CAPACITY USER as if the PROPOSED TRANSFEREE had at all times been a party to such TERMINAL USE AGREEMENT.

26.6 **PARTIAL SERVICE TRANSFER by CAPACITY USER**

A CAPACITY USER may assign, convey, transfer, or otherwise dispose of part of its rights and obligations under its TERMINAL USE AGREEMENT (a "PARTIAL SERVICE TRANSFER") to a PROPOSED TRANSFEREE, subject to the following:

- (a) CAPACITY USER and PROPOSED TRANSFEREE must jointly deliver to OPERATOR a written notice of their intention to effect such PARTIAL SERVICE TRANSFER no later than thirty (30) days before the proposed PARTIAL SERVICE TRANSFER EFFECTIVE TIME, specifying the extent and duration of the rights to SERVICES (and corresponding rights and obligations) which are to be transferred;
- (b) OPERATOR providing PARTIAL SERVICE TRANSFER APPROVAL to CAPACITY USER and PROPOSED TRANSFEREE confirming that OPERATOR consents to such PARTIAL SERVICE TRANSFER (following OPERATOR'S receipt of a valid transfer notice in accordance with AA 26.6(a)), and such PARTIAL SERVICE TRANSFER APPROVAL being counter-signed by CAPACITY USER and PROPOSED TRANSFEREE; and
- (c) the PROPOSED TRANSFEREE must have entered into a TERMINAL USE AGREEMENT on or prior to the PARTIAL SERVICE TRANSFER EFFECTIVE TIME.

CAPACITY USER agrees to perform all further acts, and execute and deliver all further documents required by law or as may be necessary (as determined by OPERATOR, acting reasonably) to implement and/or give effect to a PARTIAL SERVICE TRANSFER by or to CAPACITY USER. By delivering a transfer notice in accordance with AA 26.6(a), the PROPOSED TRANSFEREE shall be deemed to warrant at the time of such transfer notice that it will, at the PARTIAL SERVICE TRANSFER EFFECTIVE TIME, continue to meet the ACCESS REQUIREMENTS in accordance with AA 2.1 and be a PARTY to a TERMINAL USE AGREEMENT.

26.7 If a CAPACITY USER wishes to offer a PARTIAL SERVICE TRANSFER, such CAPACITY USER may:

- (a) request OPERATOR to publish the details of the proposed PARTIAL SERVICE TRANSFER on OPERATOR'S website (whereupon OPERATOR shall publish the relevant details); and/or
- (b) advertise the proposed PARTIAL SERVICE TRANSFER by such other means as it may choose,

and in either such case may withdraw or require to be withdrawn the offer of such PARTIAL SERVICE TRANSFER at any time.

26.8 Subject to an effective PARTIAL SERVICE TRANSFER having taken place in accordance with AA 26.6, and with effect from the PARTIAL SERVICE TRANSFER EFFECTIVE TIME until the PARTIAL SERVICE TRANSFER TERMINATION TIME:

- (a) the transferring CAPACITY USER will be released and discharged from all claims, demands, liabilities and obligations arising under the relevant TERMINAL USE AGREEMENT that are the subject of the relevant PARTIAL SERVICE TRANSFER;
- (b) the PROPOSED TRANSFEREE may exercise all the rights, and will assume all of the liabilities and obligations of the transferring CAPACITY USER under

the terms of the PROPOSED TRANSFEREE'S TERMINAL USE AGREEMENT, that are the subject of the PARTIAL SERVICE TRANSFER;

- (c) OPERATOR will owe its obligations under the transferring CAPACITY USER's TERMINAL USE AGREEMENT that are subject to the PARTIAL SERVICE TRANSFER to the PROPOSED TRANSFEREE under the PROPOSED TRANSFEREE'S TERMINAL USE AGREEMENT, and will be released and discharged from all obligations under the transferring CAPACITY USER's TERMINAL USE AGREEMENT to provide the transferring CAPACITY USER with SERVICES that are subject to the PARTIAL SERVICE TRANSFER; and
- (d) the applicable ANNUAL OPERATION SCHEDULE and/or THREE MONTH OPERATION SCHEDULE shall be amended to reflect the PARTIAL SERVICE TRANSFER.

26.9 If OPERATOR terminates the PROPOSED TRANSFEREE'S TERMINAL USE AGREEMENT pursuant to AA 20.4 or 20.5 due to a CAPACITY USER EVENT OF DEFAULT, then with effect from the PARTIAL SERVICE TRANSFER TERMINATION TIME:

- (a) the transferring CAPACITY USER in respect of such PARTIAL SERVICE TRANSFER shall, notwithstanding such termination, assume all the rights and obligations that are the subject of the PARTIAL SERVICE TRANSFER; and
- (b) OPERATOR will owe its obligations that were the subject to the PARTIAL SERVICE TRANSFER to the transferring CAPACITY USER under its TERMINAL USE AGREEMENT.

26.10 No Sub-letting

Save as expressly contemplated under the terms of this ACCESS ARRANGEMENT, CAPACITY USER shall not enter into any agreement or arrangement pursuant to which any third party has the right to utilise (whether in whole or part) of such CAPACITY USER'S SERVICES ENTITLEMENT.

27.0 USE IT OR LOSE IT

27.1 At any relevant time within each CONTRACT YEAR OPERATOR shall assess the utilisation of CAPACITY USER of its REGASIFICATION SERVICES ENTITLEMENT. If:

- (a) the utilisation by a CAPACITY USER of its REGASIFICATION SERVICES ENTITLEMENT during the immediately preceding six (6) calendar months is less than seventy per cent (70%) of such CAPACITY USER's REGASIFICATION SERVICES ENTITLEMENT (such CAPACITY USER being an "UNDER-USING CAPACITY USER"); and
- (b) if there is any request from any other CAPACITY USER (such CAPACITY USER being a "REQUESTING CAPACITY USER") to increase its REGASIFICATION SERVICES ENTITLEMENT,

then OPERATOR shall be required to offer on a fair and equitable basis up to thirty per cent (30%) of the UNDER-USING CAPACITY USER'S REGASIFICATION SERVICES ENTITLEMENT to the REQUESTING CAPACITY USERS and shall issue a notice of reduction to the UNDER-USING CAPACITY USER, informing it that it is an UNDER-USING CAPACITY USER and whether or not it is offering its REGASIFICATION SERVICES ENTITLEMENT to any other CAPACITY USERS in accordance with the provisions of this AA 27.1.

27.2 If OPERATOR offers REGASIFICATION SERVICE ENTITLEMENT to a REQUESTING CAPACITY USER in accordance with AA 27.1 and such REQUESTING CAPACITY USER accepts OPERATOR'S offer, OPERATOR shall accordingly reduce the UNDER-USING CAPACITY USER'S REGASIFICATION SERVICES ENTITLEMENT by that portion which is requested by the REQUESTING CAPACITY USER (provided that the amount of such reduction allocated to all REQUESTING CAPACITY USERS shall never exceed thirty per cent (30%) of the UNDER-USING CAPACITY USER'S REGASIFICATION SERVICES ENTITLEMENT, for such period as the REQUESTING CAPACITY USER has requested the additional REGASIFICATION SERVICES ENTITLEMENT (such period, the "UIOLI PERIOD").

27.3 UNDER-USING CAPACITY USER'S TERMINAL USE AGREEMENT shall be deemed amended mutatis mutandis to reflect the reduction in the REGASIFICATION SERVICES ENTITLEMENT for the UIOLI PERIOD.

27.4 REQUESTING CAPACITY USER's TERMINAL USE AGREEMENT shall be deemed amended mutatis mutandis to reflect the increase in its REGASIFICATION SERVICES ENTITLEMENT for the UIOLI PERIOD.

27.5 If OPERATOR offers REGASIFICATION SERVICE ENTITLEMENT to a REQUESTING CAPACITY USER in accordance with AA 27.1 and such REQUESTING CAPACITY USER declines OPERATOR'S offer, all rights and obligations in respect of the REGASIFICATION SERVICE ENTITLEMENT so offered remain with the original CAPACITY USER.

28.0 INTER-CAPACITY USER AGREEMENT

28.1 Each CAPACITY USER shall at all times be party to an INTER-CAPACITY USER AGREEMENT provided that, in all cases, CAPACITY USER will remain liable for the payment and performance of all of its obligations under the TERMINAL USE AGREEMENT.

29.0 REVISIONS TO THE ACCESS ARRANGEMENT

29.1 OPERATOR'S role

OPERATOR shall be entitled to propose amendments or modifications to this ACCESS ARRANGEMENT (each a "PROPOSED AA CHANGE"):

- (a) on its own accord; or

- (b) as a result of any directions from the ENERGY COMMISSION; or
- (c) as a result of any change requests (each an "AA CHANGE REQUEST") received from CAPACITY USERS (either individually or collectively) in accordance with the procedure set out below in AA 29.2.

29.2 Change request procedure

- (a) CAPACITY USER(S) may submit a AA CHANGE REQUEST to OPERATOR no later than six (6) CONTRACT MONTHS before the PROPOSED AA CHANGE is scheduled to take place.
- (b) The AA CHANGE REQUEST must include sufficient details on the changes being proposed by the CAPACITY USER(S), including a rationale and justification (as well as any relevant supporting documentation) for such changes.
- (c) Upon receipt of an AA CHANGE REQUEST, OPERATOR shall analyse and evaluate the AA CHANGE REQUEST, and may reasonably request any additional information and/or clarification from the CAPACITY USER(s).
- (d) Provided that OPERATOR is satisfied that the proposed changes contained therein are not inconsistent with the TPA CODE (and any other relevant codes developed and issued under the GAS SUPPLY ACT), OPERATOR shall publish the AA CHANGE REQUEST with the PROPOSED AA CHANGES which OPERATOR considers necessary to effect such AA CHANGE REQUEST for consultation in accordance with AA 29.3.

29.3 Consultation

OPERATOR shall publish the PROPOSED AA CHANGES (and relevant AA CHANGE REQUEST, if applicable) on its website. OPERATOR shall consult with the CAPACITY USER(S) on the PROPOSED AA CHANGES for ninety (90) days thereafter.

29.4 ENERGY COMMISSION approval

Within thirty (30) days after the end of the consultation period in AA 29.3, OPERATOR shall forward the PROPOSED AA CHANGES (including any modifications arising from the consultation process) to the ENERGY COMMISSION for prior approval.

Within fourteen (14) days of the ENERGY COMMISSION'S approval of the PROPOSED AA CHANGES (as modified, if necessary), OPERATOR shall publish the updated ACCESS ARRANGEMENT on its website and notify each of the CAPACITY USERS.

30.0 FURTHER ASSURANCE

Each PARTY shall co-operate with the other and execute and deliver to the other such other instruments and documents and take such other actions as may be reasonably requested from time to time in order to carry out, evidence and confirm their rights and the intended purpose of the TERMINAL USE AGREEMENT.

31.0 ENTIRE AGREEMENT

- (a) The TERMINAL USE AGREEMENT in relation to the matters contained herein constitute the entire agreement between the PARTIES
- (b) Save as otherwise expressly provided no modification, amendment or waiver of any of the provisions of the TERMINAL USE AGREEMENT shall be effective unless made in writing specifically referring to the TERMINAL USE AGREEMENT and duly signed by the PARTIES.

32.0 SURVIVAL OF RIGHTS, DUTIES AND OBLIGATIONS

Termination of the TERMINAL USE AGREEMENT for any cause shall not release a PARTY from any liability which at the time of termination has already accrued to another PARTY or which thereafter may accrue in respect of any act or omission prior to such termination.

33.0 ANNOUNCEMENTS

No PARTY shall make any press or other public announcement concerning any aspect of the TERMINAL USE AGREEMENT without first obtaining the agreement of the other PARTY to the text of that announcement.

34.0 SEVERANCE

If any provision of the TERMINAL USE AGREEMENT or part thereof is rendered void, illegal or unenforceable in any respect under any law, the validity, legality and enforceability of the remaining provisions shall not in any way be affected or impaired thereby.

35.0 WAIVER

The failure of a PARTY at any time to require performance of any of the provisions contained in the TERMINAL USE AGREEMENT shall in no way affect the rights of such PARTY to require any performance which may be due thereafter pursuant to such provisions, nor shall the waiver by a PARTY of any such breach of any provision hereof be taken or held to be a waiver of any subsequent breach of such provision.

36.0 MITIGATION

Each PARTY shall use its REASONABLE ENDEAVOURS to mitigate any direct costs, losses and expenses in respect of which such PARTY is indemnified by the other PARTY pursuant to the TERMINAL USE AGREEMENT.

37.0 EXPERT DETERMINATION

37.1 In the event of a DISPUTE arising out of or relating to AAs 10.1, 10.2, 12.0 or 17.6, either PARTY may notify the other PARTY in writing of the DISPUTE (the "DISPUTE NOTICE") together with reasonable details of such DISPUTE. The PARTIES will then endeavour to resolve all matters in dispute as soon as reasonably practicable.

37.2 In the event of their failing to resolve such matters within twenty-one (21) days of service of the DISPUTE NOTICE, either PARTY may submit such DISPUTE to

administered expert proceedings in accordance with the Rules for the Administration of Expert Proceedings of the International Chamber of Commerce. The parties agree that the findings of the expert so appointed (the "EXPERT") shall (in the absence of manifest error or fraud) be contractually binding upon them.

- 37.3 The expert determination process is private and confidential except in relation to enforcement or if required by law or for disclosure to advisors appointed by the EXPERT (on the basis that such parties are subject to the same confidentiality obligations).
- 37.4 All proceedings before the EXPERT shall be conducted in the English language and all documents submitted in connection with such proceedings shall either be in the English language or, if in another language, accompanied by a certified translation.
- 37.5 In the event that any DISPUTE which is to be decided pursuant to AA 37.2 above and any ongoing RELATED DISPUTE which has also been referred to an EXPERT for determination give rise to one or more common issues of fact or law, the PARTIES agree that both the DISPUTE and the RELATED DISPUTE shall be determined (separately) by whichever EXPERT was first appointed.
- 37.6 Where any DISPUTE which is to be decided pursuant to AA 37.2 above and a RELATED DISPUTE arising out of or relating to AAs 10.1, 10.2, or 12.0, give rise to one (1) or more common issues of fact or law and an EXPERT has yet to be appointed in relation to either, the PARTIES agree to appoint the same person as the EXPERT to determine both (at the same time).
- 37.7 If the DISPUTE and any RELATED DISPUTE which has already been determined give rise to common issues of fact or law, the PARTIES agree that submissions and evidence adduced, and the determination made, in the RELATED DISPUTE shall be admissible as evidence in the expert determination concerning the DISPUTE.

38.0 DISPUTE RESOLUTION

- 38.1 Save for those DISPUTES which are to be resolved under AA 37.0 or which arise with respect to matters falling under sections 13 or 14 to 21 of the GAS SUPPLY ACT (and that are referred to the ENERGY COMMISSION for determination in accordance with section 29 of the GAS SUPPLY ACT), any DISPUTE shall be settled in accordance with this AA 38.0 and in the spirit of mutual co-operation and goodwill. Any DISPUTE may be referred by either PARTY by written notice setting out a summary of the facts of the DISPUTE, to a dispute resolution committee (the "DISPUTE RESOLUTION COMMITTEE"). The DISPUTE RESOLUTION COMMITTEE shall consist of:

- (a) one (1) representative nominated by CAPACITY USER; and
- (b) one (1) representative nominated by OPERATOR,

each of which representatives shall have the authority to negotiate and agree an amicable settlement of any DISPUTE referred to it.

- 38.2 If any DISPUTE which is referred to the DISPUTE RESOLUTION COMMITTEE is not resolved amicably within thirty (30) days after the date of referral, either PARTY may refer that DISPUTE to be finally settled by arbitration in accordance with the

Rules of Arbitration of the Asian International Arbitration Centre (the "AIAC"). For the avoidance of doubt, the AIAC shall be the appointing authority.

- 38.3 The seat, or legal place, of arbitration shall be Malaysia.
- 38.4 The arbitration shall be conducted in the English language, and the place of arbitration shall be Kuala Lumpur. The decision of the arbitrators shall be final and binding on the PARTIES hereto.
- 38.5 The number of arbitrators shall be three. One (1) arbitrator shall be nominated by CAPACITY USER, and one (1) arbitrator shall be nominated by OPERATOR. The two persons so nominated shall within fourteen (14) days of the appointment of the second of them, nominate a third arbitrator who shall act as the presiding arbitrator of the tribunal. If no such nomination is made within the time limit, then the appointing authority of the AIAC shall select and appoint the presiding arbitrator of the tribunal.
- 38.6 When a matter is referred to arbitration under the TERMINAL USE AGREEMENT, it shall not prevent or constitute a valid excuse for either PARTY from performing its respective obligations under the TERMINAL USE AGREEMENT.
- 38.7 Subject to AA 38.7(e) below, the PARTIES agree as follows:
- (a) Where a RELATED DISPUTE arises which raises substantially the same or connected factual and/or legal issues as a DISPUTE under the TERMINAL USE AGREEMENT (whether or not arbitration of the RELATED DISPUTE has already been commenced) (the "COMMON DISPUTES"), then on request, the AIAC can appoint the same tribunal in respect of the COMMON DISPUTES (the "COMMON TRIBUNAL"). Where arbitrators have already been appointed to determine any of the COMMON DISPUTES, the tribunal first appointed will constitute the COMMON TRIBUNAL. The parties will ensure that the appointment of any other arbitrator is terminated immediately. The termination is without prejudice to:
 - (i) the validity of any act done or order made by that arbitrator or by the court in support of that arbitration before his appointment is terminated;
 - (ii) his entitlement to be paid his proper fees and disbursements; and
 - (iii) the date when any claim or defence was raised for the purpose of applying any limitation bar or any similar rule or provision.
 - (b) If it considers it to be in the interests of justice and efficiency, the COMMON TRIBUNAL can order the COMMON DISPUTES to be consolidated (a "CONSOLIDATION ORDER"). On making a CONSOLIDATION ORDER, the COMMON TRIBUNAL will have exclusive jurisdiction to resolve the COMMON DISPUTES.
 - (c) If a CONSOLIDATION ORDER is made, the parties to each of the proceedings that are the subject of the order will be treated as having consented to the consolidated proceedings. The CONSOLIDATION ORDER and the award of the COMMON TRIBUNAL will be final and binding.

- (d) Each PARTY agrees that:
 - (i) that the arbitral tribunal has power to join any party that is not party to the arbitration to the proceedings (an "ADDITIONAL PARTY") and each PARTY consents to such joinder;
 - (ii) that it may be joined as an ADDITIONAL PARTY to any arbitration commenced under a TERMINAL USE AGREEMENT or the INTER-CAPACITY USER AGREEMENT; and
 - (iii) not to unreasonably object to the joinder or otherwise obstruct any attempt to join an ADDITIONAL PARTY.
- (e) The AIAC and arbitral tribunal may only exercise the powers in this clause AA 38.7 if all parties to the relevant arbitral proceedings (including in relation to AA 38.7(d), any ADDITIONAL PARTY) have been given a reasonable opportunity to make representations to the AIAC or arbitral tribunal in relation to the exercise of such powers.
- (f) If more than two parties are involved in any arbitral proceedings, the arbitral tribunal shall have all powers necessary to establish any supplementary procedural rules required or desirable in view of the multi-party nature of the arbitral proceedings. Such powers shall include the ability to issue one or more arbitration awards during or at the conclusion of the arbitration as considered necessary or appropriate or expedient by the arbitral tribunal.

38.8 Where the same or related issues of fact or law arise in two or more arbitration proceedings, evidence adduced and awards rendered in one such arbitration shall be admissible as evidence in the other(s). Subject to the above, the PARTIES agree that all arbitration proceedings shall be kept confidential and that the existence of the proceedings and all elements thereof (including but not limited to any pleadings, briefs or other documents submitted or exchanged, any testimony or other oral submissions, and any awards) shall not be disclosed beyond the tribunal, the AIAC, the PARTIES, their counsel and any person necessary for the conduct of the proceedings, except as may be lawfully required in judicial proceedings relating thereto or to the award resulting therefrom, or as may otherwise be required by APPLICABLE LAWS.

38.9 By agreeing to arbitration under this AA 38.0, the PARTIES do not intend to deprive any court of its jurisdiction to issue an interim injunction or other interim relief in aid of the arbitration proceedings or the enforcement of any award, provided that the PARTIES agree that they may seek only such relief as is consistent with their agreement to resolve any dispute by way of arbitration. Without prejudice to such interim remedies in aid of arbitration as may be available under the jurisdiction of a court or otherwise, the arbitral tribunal shall also have full authority to grant interim remedies and to award damages for the failure of a PARTY to respect a court's or the arbitral tribunal's orders to that effect.

39.0 GOVERNING LAW

The TERMINAL USE AGREEMENT and any DISPUTE, shall be wholly and exclusively governed by and construed in accordance with the laws of Malaysia, save that Articles 41, 42 and 43 of the Arbitration Act, 2005 shall not apply.

40.0 SOVEREIGN IMMUNITY

40.1 The PARTIES recognise and acknowledge that the TERMINAL USE AGREEMENT is intended to constitute a commercial transaction and accordingly each PARTY acknowledges and agrees that it is not entitled to, and hereby irrevocably waives any right to, plead sovereign immunity for any purpose whatsoever, including, but not limited to, any right to plead sovereign immunity in respect of any action:

- (a) to refer a matter to an EXPERT, or to arbitration, pursuant to the terms of the TERMINAL USE AGREEMENT; or
- (b) in respect of the jurisdiction of the EXPERT or arbitral tribunal; or
- (c) to enforce or execute any award or determination rendered by an arbitral tribunal or any EXPERT pursuant to the terms of the TERMINAL USE AGREEMENT.

40.2 The PARTIES irrevocably waive any claim to sovereign immunity in relation to any court proceedings arising out of or in connection with a TERMINAL USE AGREEMENT, including for the purposes of enforcing any award or determination rendered by an arbitral tribunal or any EXPERT pursuant to the terms of the TERMINAL USE AGREEMENT.

40.3 Each of the PARTIES consents generally to the giving of any relief or the issuing of any process, including the making, enforcement or execution against any property of any order or judgement, in respect of:

- (a) any suit, legal action or proceedings arising out of or in connection with the TERMINAL USE AGREEMENT for the purpose of enforcing any order or any award made in any arbitration; or
- (b) any determination of any EXPERT.

40.4 To the extent that:

- (a) either PARTY may be entitled in any jurisdiction to claim for itself or its assets sovereign immunity in respect of its obligations under the TERMINAL USE AGREEMENT; or
- (b) in any jurisdiction there may be attributed to itself or its assets such sovereign immunity,

each of the PARTIES agrees not to claim and hereby irrevocably waives such sovereign immunity to the fullest extent permitted by the laws of such jurisdiction.

41.0 CODE OF CONDUCT AND BUSINESS ETHICS

41.1 For the purpose of this AA 41.0, each of the following expressions have, except where the context otherwise requires, the following meanings:

- (a) "ASSOCIATED PERSONS" means a person associated with the CAPACITY USER, including, but not limited to any of its employees, agents, subcontractors, consultants, representatives and agents;
- (b) "PETRONAS ABC POLICY" means the PETRONAS Code of Conduct and Business Ethics and Country Supplement, and other related rules, regulations, policies, procedures, guidelines and requirements as updated from time to time;
- (c) "RELEVANT REQUIREMENTS" means all applicable laws, statutes, regulations and codes relating to anti-bribery and anti-corruption;
- (d) "RELEVANT POLICIES" means Part II A (Conflict of Interest) and Part II B (Fighting Corruption and Unethical Practices) of the PETRONAS Code of Conduct and Business Ethics and other related policies, procedures, guidelines and requirements as updated by the OPERATOR from time to time; and
- (e) "RELEVANT OBLIGATIONS" means obligations equivalent to those imposed on CAPACITY USER pursuant to the terms of this AA 41.0.

41.2 Business Conduct

- (a) CAPACITY USER shall comply with the PETRONAS ABC POLICY at all times.
- (b) CAPACITY USER shall ensure that all ASSOCIATED PERSONS shall comply with the PETRONAS ABC POLICY in connection with the TERMINAL USE AGREEMENT.
- (c) From time to time, at the request of OPERATOR, CAPACITY USER shall confirm in writing that CAPACITY USER and any ASSOCIATED PERSONS have complied with the obligations imposed upon it in this AA 41.2 and provide any information reasonably requested by OPERATOR in support of the compliance obligations.
- (d) In the event that CAPACITY USER and/or the ASSOCIATED PERSONS refuse, fail and/or is negligent in complying with the provisions of this AA 41.2, OPERATOR may, without prejudice to any other remedies available to it under the TERMINAL USE AGREEMENT or under the laws, take any such action as deemed necessary including termination of the TERMINAL USE AGREEMENT.

41.3 Conflict of Interest and Fighting Corruption and Unethical Practices

- (a) CAPACITY USER shall:
 - (i) comply with all RELEVANT REQUIREMENTS and RELEVANT POLICIES;

- (ii) have in place and maintain throughout the TERM its own policies and procedures to ensure compliance with the RELEVANT REQUIREMENTS and RELEVANT POLICIES;
 - (iii) with respect to any matter arising out of the TERMINAL USE AGREEMENT, maintain adequate internal controls and accurately record all transactions in its books and records;
 - (iv) enforce the policies and procedures referred to in AA 41.3(a)(ii) above, where appropriate;
 - (v) promptly report to OPERATOR any breach of this AA 42.3.(a) arising in connection with the TERMINAL USE AGREEMENT and take such steps as OPERATOR may reasonably require in order to rectify any such breach;
 - (vi) promptly report any request or demand for any undue financial or other advantage of any kind received by OPERATOR in connection with the performance of the TERMINAL USE AGREEMENT and take such steps in response to any such request as OPERATOR may require; and
 - (vii) immediately notify OPERATOR in writing if a foreign public official becomes an officer or employee of CAPACITY USER or acquires a direct or indirect interest in CAPACITY USER.
- (b) CAPACITY USER warrants that no foreign public officials are officers or employees of CAPACITY USER or have direct or indirect interests in CAPACITY USER at the date of the TERMINAL USE AGREEMENT.
 - (c) CAPACITY USER shall ensure that in connection with the TERMINAL USE AGREEMENT all ASSOCIATED PERSONS shall be subject to a written contract which imposes RELEVANT OBLIGATIONS on the ASSOCIATED PERSONS.
 - (d) CAPACITY USER shall be responsible for the observance and performance by the ASSOCIATED PERSONS of the RELEVANT OBLIGATIONS and shall be directly liable to OPERATOR for any breach of the RELEVANT OBLIGATIONS by any ASSOCIATED PERSON.
 - (e) Breach of this AA 41.3 shall be deemed a material breach and OPERATOR may terminate the TERMINAL USE AGREEMENT, without any ensuing obligations nor liabilities, except for that incurred prior to the date of the breach.

42.0 DISCLAIMER OF AGENCY

- (a) It is not the intention of the PARTIES to create, nor shall the TERMINAL USE AGREEMENT be deemed or construed to create, nor shall the PARTIES report for any purpose any transaction occurring pursuant to the TERMINAL USE AGREEMENT as a partnership, joint venture or other association or a trust.
- (b) The TERMINAL USE AGREEMENT shall not be deemed or construed to authorise any PARTY to act as an agent, servant or employee for the other

PARTY for any purpose whatsoever except as explicitly set forth in the TERMINAL USE AGREEMENT. In their relations with each other under the TERMINAL USE AGREEMENT, the PARTIES shall not be considered fiduciaries.

43.0 REPRESENTATIONS AND WARRANTIES

43.1 OPERATOR'S warranties as to authority

OPERATOR represents and warrants to CAPACITY USER that, as at the EFFECTIVE DATE:

- (a) OPERATOR is a company validly incorporated under the laws of Malaysia;
- (b) OPERATOR has full power, authority, and legal right to own its assets and conduct its business as currently conducted and has taken all necessary corporate action to sign and deliver the TERMINAL USE AGREEMENT and perform its obligations under the TERMINAL USE AGREEMENT; and
- (c) the TERMINAL USE AGREEMENT has been duly signed and delivered by OPERATOR and forms a valid and binding obligation of OPERATOR, enforceable against OPERATOR under its terms.

43.2 CAPACITY USER'S warranties as to authority and credit worthiness

CAPACITY USER represents and warrants to OPERATOR that, as at the EFFECTIVE DATE:

- (a) CAPACITY USER is in good financial standing as required for performance under the TERMINAL USE AGREEMENT;
- (b) CAPACITY USER has or causes to have full power, authority, and legal right to own its assets and conduct its business as currently conducted and has taken all necessary corporate action to sign and deliver the TERMINAL USE AGREEMENT and perform its obligations under the TERMINAL USE AGREEMENT;
- (c) the TERMINAL USE AGREEMENT has been duly signed and delivered by CAPACITY USER and forms a valid and binding obligation of CAPACITY USER, enforceable against CAPACITY USER under its terms; and
- (d) CAPACITY USER has furnished to OPERATOR certified resolutions, or authenticated powers-of-attorney, or other corporate instruments necessary to authorize its execution, delivery, and performance of the TERMINAL USE AGREEMENT.

43.3 Additional representations and warranties of CAPACITY USER

In addition to the representations and warranties set out in AA 43.2, CAPACITY USER represents and warrants to OPERATOR that, as at the EFFECTIVE DATE:

- (a) the execution and delivery of the TERMINAL USE AGREEMENT by CAPACITY USER does not and the performance of the TERMINAL USE AGREEMENT will not:
 - (i) violate any provision of its governing documents or any APPLICABLE LAWS presently in effect applicable to it or its properties or assets;
 - (ii) result in a breach of or be a default under any credit agreement or other agreement or instrument to or by which it or its properties or assets may be presently bound or affected; and
 - (iii) result in or require the creation or imposition of any encumbrance upon or of any of its properties or assets under any credit agreement, other agreement, or instrument;
- (b) there are no suits, judicial, or administrative actions, proceedings, or investigations (including bankruptcy, reorganisation, insolvency, or similar actions, proceedings, or investigations) pending or, to its knowledge, threatened against it before any court or by or before any GOVERNMENTAL AUTHORITY that, if decided adversely to its interest, could materially adversely affect its ability to perform its obligations under the TERMINAL USE AGREEMENT; and
- (c) all approvals, consents, or permissions of, and notifications or filings with, any person necessary for CAPACITY USER'S valid execution, delivery, and performance of the TERMINAL USE AGREEMENT have been obtained, are in full force and effect, and are final and not subject to appeal.

43.4 Duration of representations and warranties

Each PARTY represents and warrants to the other that the PARTIES have entered into the TERMINAL USE AGREEMENT, on the basis of and in reliance on the following:

- (a) the truth and correctness of the representations and warranties;
- (b) the representations and warranties shall on the EFFECTIVE DATE be true and accurate as if they were given immediately before the EFFECTIVE DATE; and
- (c) the representations and warranties shall remain in full force and effect notwithstanding the EFFECTIVE DATE.

43.5 Notice regarding representations and warranties

Each PARTY shall give notice to the other PARTY of any matter or event coming to its attention at any time which shows or may show that any representation or warranty made by that PARTY as set out in this AA 43.0 was when it made or at any time thereafter has become untrue, inaccurate or misleading in any respect.

43.6 CAPACITY USER'S covenants

- (a) CAPACITY USER covenants with OPERATOR that at no cost to OPERATOR, CAPACITY USER must:
- (i) obtain consents, approvals or permissions, if necessary, to enable CAPACITY USER to perform CAPACITY USER'S obligations and the transactions contemplated by the TERMINAL USE AGREEMENT;
 - (ii) notify OPERATOR immediately if any of the said consents, approvals or permissions referred to in AA 43.6(a)(i), are not granted, have lapsed and are not renewed, are cancelled or terminated or if any proceeding is initiated; and
 - (iii) adhere to OPERATOR'S credit terms and/or the terms of any security required to be provided by CAPACITY USER for payment and performance of its obligations under the TERMINAL USE AGREEMENT.

43.7 Mutual covenants

Each PARTY covenants to the other that the PARTY will comply with all APPLICABLE LAWS, including the TPA CODE and GAS SUPPLY ACT, governing or relating to its performance under the TERMINAL USE AGREEMENT.

44.0 CHANGE OF CIRCUMSTANCES

With the object of ensuring that the TERMINAL USE AGREEMENT (excluding this ACCESS ARRANGEMENT) remains fair and reasonable for its full term, if any substantial change in circumstances (including any change to the legal or regulatory regime affecting the RECEIVING FACILITY) at any time during the TERM seriously prejudices or is foreseen seriously to prejudice any PARTY in relation to the TERMINAL USE AGREEMENT (excluding this ACCESS ARRANGEMENT), then the PARTIES at the written request of either PARTY, shall immediately consult together in a spirit of mutual understanding and co-operation and shall decide, if necessary subject to the approval of the ENERGY COMMISSION whether and what revision of the terms and conditions of the TERMINAL USE AGREEMENT (excluding this ACCESS ARRANGEMENT) is reasonably necessary in view of the change in circumstances. Pending agreement on the revised terms and conditions or in the event that no revision is agreed upon, the terms and conditions contained in the TERMINAL USE AGREEMENT (excluding this ACCESS ARRANGEMENT) shall apply. This AA 44.0 shall be without prejudice to clause 16.0 of the INTER-CAPACITY AGREEMENT.

SCHEDULE 1 LNG VESSELS SPECIFICATIONS & VETTING PROCEDURES

1. LNG VESSEL shall conform to the following parameters:

Gross vessel capacity:

5,000 cubic metres to the maximum of 270,000 cubic metres

Minimum/ Maximum overall length:

100 metres/ 345 metres

Maximum permitted draft:

13.7 metres

Maximum cargo capacity means:

- (a) 177,000 cubic metres of LNG in respect of any LNG VESSEL with a spherical LNG containment system;
 - (b) 270,000 cubic metres of LNG in respect of any LNG VESSEL with a membrane LNG containment system; and
 - (c) Final acceptance of nominated vessel still subject to compatibility study and OPERATOR.
2. RECEIVING FACILITIES are capable to receive LNG VESSEL discharge rate up to 14,000 cubic metres per hour of LNG. LNG VESSEL shall have a 16 inch diameter presentation flange that meets Oil Company International Marine Forum (OCIMF) Standards.
3. LNG VESSEL shall apply and comply with SIRE requirement as per latest PETRONAS Technical Standard as the following vetting process:

ROLES	PROCESSES
CHARTERERS / TRADERS	VESSEL NOMINATION ↓
APPROVED VETTING COMPANY / CHARTERERS / TRADERS / TERMINAL	VESSEL VETTING CRITERIA ↓
TERMINAL / FIELD OPERATOR	VESSEL ACCEPTANCE / TRADERS / TERMINAL ↓
CHARTERERS / TRADERS / TERMINALS / FIELD OPERATOR	VESSEL IN SERVICE ↓
CHARTERERS / TRADERS	VESSEL TERMINATION AND/OR END OF CONTRACTED PERIOD

4. LNG VESSEL must follow acceptance process stated in Confirmation List before being accepted to the terminal with the following document to be provided to the terminal:
- OCIMF Vessel Particular Questionnaire (VPQ) less than one year old
 - Optimoor mooring study or equivalent based on OCIMF recommended criteria
 - Gas Form C
 - Survey Class Status Report less than 1 month old
 - LNG Vessel valid cert of entry with P&I Club and Wreck Removal Certificate
 - LNG Vessel Cargo Tank Gauging Table
 - LNG Vessel Custody Transfer Calibration Certification +Gas Flow Meter to Engineer Room Calibration Certificate
 - Gangway photo landing area
 - General Vessel Arrangement and Manifold arrangement
5. Short Distance Piece (SDP) whenever required.
6. The LNG VESSEL must arrive with a cargo saturation pressure of between 70 mbarg and 150 mbarg.
7. The LNG VESSEL must have the ability to receive back vapours during discharge.

8. The LNG VESSEL shall be able to receive vapour return from shore, initially at ambient temperatures and gradually cooling down as flow rates increase and the line-work cools down.
9. The LNG VESSEL must have a winch with maximum winch brake holding power of 80T with all mooring lines running on winches and fitted out with soft tails. Mooring patterns must comply with OCIMF Standards. Mooring line configuration must follow the outcomes of Optimoor result.
10. The LNG VESSEL shall have ship-shore communication based on 6 way fibre-optic cable with back-up from an electric Pyle National 37 pin -pin connector.

SCHEDULE 2 MEASUREMENT RULES

1.1 Measurement of quantity of LNG Received from CAPACITY USER'S LNG VESSEL(S)

- (a) CAPACITY USER shall supply, operate and maintain, or caused to be supplied, operated and maintained, suitable gauging devices for the LNG tanks of the LNG VESSEL, as well as pressure and temperature measuring devices, in accordance with these MEASUREMENT RULES and any other measurement, gauging or testing devices which are incorporated in the structure of the LNG VESSEL or customarily maintained on board the LNG VESSEL
- (b) The volume of LNG discharged by CAPACITY USER at RECEIVING FACILITY shall be measured or caused to be measured in cubic meter by gauging the LNG in the tanks of LNG VESSEL. Each tank shall be equipped with primary and secondary liquid level tank measuring devices with proven technologies in the LNG industry, or otherwise to be agreed by OPERATOR. The correction factors such as temperature, pressure, trim and least shall be put into account in the gauging correction tables.
- (c) Immediately before the commencement of loading (i.e. immediately prior to opening the vapour manifold ESD valve of the LNG VESSEL) the initial gauging of the LNG VESSEL'S tanks shall be conducted five (5) minutes following: (a) the confirmation of complete stoppage of the L/D compressor and spray pumps; (b) closure of gas master valve to the machinery spaces and; (c) liquid lines drained if lines cooled prior to berthing.
- (d) The final gauging of the LNG VESSEL'S tanks and pipelines shall be carried out immediately after the completion of loading and the draining of the liquid arms is completed and all ESD valves are closed (i.e. immediately following five (5) minutes after closure of vapour manifold ESD valve of the LNG VESSEL). The complete closure of gas master valve to the machinery spaces is required during this period.
- (e) Representatives of CAPACITY USER and OPERATOR shall have the right to be present at such gaugings but the absence of a representative shall not prohibit any gauging. CAPACITY USER shall perform, or cause to be performed, measurement of liquid temperature, vapour temperature and vapour pressure in each LNG VESSEL, and gauging of the trim and list of the LNG VESSEL, before commencement of LNG unloading and after completion of LNG unloading.
- (f) CAPACITY USER shall send, or cause to be sent to OPERATOR a certified copy of the gauging standards for each tank of the LNG VESSEL being used to deliver the LNG as well as correction charts (e.g. list, trim, tanks' contraction, etc.). Such standards and charts shall be used throughout the term of this ACCESS ARRANGEMENT, except in the case of a physical change or re-calibration of the tanks, in which case new standards and charts shall be used. Re-gauging results from each dry docking shall be made available to OPERATOR.
- (g) The density of the LNG shall be calculated as per ISO 6578 (or such other method as may be agreed between the PARTIES).
- (h) The temperature of the LNG contained in the tanks of the LNG VESSEL shall be determined by an INDEPENDENT SURVEYOR appointed by OPERATOR on behalf of the PARTIES, using the arithmetic average of the temperature indicated by special

thermo-couples or resistance thermometers spaced at various locations from top to bottom of each tank with an accuracy of plus or minus two-tenths (0.2) of a degree Celsius. Such temperatures shall be recorded.

- (i) OPERATOR shall supply, operate and maintain, or caused to be supplied, operated and maintained, devices required for collecting samples and for determining quality and composition of the delivered LNG, in accordance with these MEASUREMENT RULES and any other measurement, gauging or sampling devices which are necessary to perform the measurement and testing required at the RECEIVING FACILITY. OPERATOR may take samples of the LNG from each CARGO unloaded with a frequency adequate to ensure a representative analysis of the LNG being unloaded, at a suitable point between the LNG RECEIPT POINT and STORAGE TANKS and such sampling and testing procedures based on ISO 8943 (auto sampling), ISO 6974 (analysis for online), GIIGNL LNG CUSTODY TRANSFER HANDBOOK, GPA 2261 (lab) and ASTM D1945 (lab) or equivalent.
- (j) The sampling device shall permit the total and continuous vaporisation of LNG quantity sufficient for the taking of a gaseous sample representative of the LNG then being unloaded. Such samples shall be analysed by Gas Chromatograph (GC). An analysis of the average of such analyses shall determine the molecular composition of the LNG. A calibration of the chromatograph utilised shall be performed before the analysis of the samples taken from each unloading and reloading.
- (k) CAPACITY USER shall not prevent OPERATOR from carrying out the calibration and sampling, although CAPACITY USER shall be entitled to attend and witness the analysis of such LNG. Such calibration shall be effected with the aid of a gaseous mixture having a known composition closely similar to the vaporised LNG being measured.
- (l) The Gross Heating Value (GHV) of LNG shall be calculated on the basis of its molecular composition and of the molecular weights and the Mega Joules per kilogram (MJ/kg) and British Thermal Unit per kilogram (Btu/kg) of each of its components. The values of physical constants to be used for such calculations shall conform in the most current publications of ISO 6976.
- (m) The quantity of LNG unloaded in Giga Joules (GJ) and Million British Thermal Unit (mmBtu). The calculation shall be based upon the GIIGNL Custody Transfer Handbook and international best practices and prepared by the INDEPENDENT SURVEYOR.
- (n) OPERATOR shall in addition to the tests set out above, be entitled to take up to three (3) manual sampling bombs. These sampling bombs shall be kept by OPERATOR for maximum up to seven (7) days and may be used in any dispute between PARTIES in respect of these sampling bombs.
- (o) In the event the GC malfunctions or fails to provide accurate analysis result, OPERATOR shall use one (1) of the manual sampling taken for the purpose of testing and analysing the delivered LNG. The sampling system shall be designed in accordance to ISO 8943.

1.2 Gauging Equipment

- (a) CAPACITY USER shall cause to be supplied, operated and maintained, equipment for accurately gauging the level of liquid and liquid temperature in the LNG VESSEL's tanks. Such devices shall be accurate within the limits of accuracy specified herein and the degree of accuracy of such devices shall be verified by the INDEPENDENT SURVEYOR in accordance with paragraphs 1.10 and 1.11. All equipment, instruments and devices shall meet and be operated and maintained in accordance with INTERNATIONAL LNG TERMINAL STANDARDS.
- (b) All measurements and calculations relating to:
 - (A) gauging of LNG shall be performed or cause to be performed by CAPACITY USER;
 - (B) testing of the quality and composition of the LNG shall be performed by OPERATOR;
 - (C) determination of the LNG density and quantity shall be performed by an INDEPENDENT SURVEYOR; and
 - (D) verification of (A) and (B) shall be performed by the INDEPENDENT SURVEYOR.
- (c) Prior to carrying out measurements and gauging in accordance with this Schedule 2, CAPACITY USER and OPERATOR shall each notify the designated representatives of the other allowing such representative a reasonable opportunity to be present for such measurements and gaugings, but the absence of a duly notified representative shall not prevent either the carrying out of the measurements or the preparation of the calculations.
- (d) All testing data, charts, calculations or any other similar information shall be made available to PARTIES.

1.3 **Verification of accuracy of unloaded LNG**

- (a) CAPACITY USER shall regularly test and verify the accuracy of its devices. In the case of gauging devices of LNG VESSELS referred to herein such tests and verifications shall take place during each scheduled dry-docking, provided that the interval between such test and verifications shall not exceed three (3) years. CAPACITY USER shall also test redundant determining devices and report their indications to OPERATOR for verification purposes.
- (b) If OPERATOR has reasonable doubts as to the accuracy of such devices it may, on an exceptional basis and after having notified CAPACITY USER in advance, request the testing and verification of the accuracy of such device prior to the next scheduled testing and verification.
- (c) OPERATOR shall from time to time and at least every three (3) years test and verify the accuracy of RECEIVING FACILITY's devices referred to herein. If CAPACITY USER reasonably queries the accuracy of such devices it may, on an exceptional basis and after having notified OPERATOR in advance, request the testing or verification of the accuracy of such a device prior to the next scheduled testing and

verification; provided that this does not interfere with OPERATOR's normal operations of RECEIVING FACILITY.

- (d) Testing and verification of such devices shall be performed using methods that are recommended by the manufacturers or that are standard to the LNG industry.
- (e) Without prejudice to paragraph 1.3(d) if, at the time of verification, a measuring instrument is found to result in errors of one (1) per cent or less of unloaded LNG, such equipment's previous measurements shall be considered accurate for purposes of delivery calculations and such equipment shall be adjusted forthwith as necessary. If, at the time of verification, a measuring instrument is found to result in errors of more than one (1) per cent of unloaded LNG such equipment's previous measurements shall be brought to a zero difference by comparison with calibration results for any period known definitively or agreed to have been affected by such error, and the calculation of deliveries made during said period shall be corrected accordingly. However, in the event that the period during which such error occurred is not definitively known or agreed upon, corrections shall be made for those quantities received or delivered during the last half of the period since the date of the last calibration.
- (f) Following any such correction, the amount of unloaded LNG (for each relevant unloading of LNG VESSEL) shall be adjusted and the consequent adjustment made in respect of CAPACITY USER's inventory.
- (g) The installation and operation of devices for measuring the level of LNG pressure in the tanks of the LNG VESSEL(s), as well as chromatographs used for the analysis of unloaded LNG, shall be carried out according to the manufacturers' specifications and INTERNATIONAL LNG TERMINAL STANDARDS.
- (h) All instruments and gauges used for computing the unloaded LNG hereunder shall be calibrated in the following manner:
 - (A) in cubic metres (m³);
 - (B) in degrees Celcius (0°C);
 - (C) mass in kg;
 - (D) energy in GHV (MJ/kg);
 - (E) density (kg/ m³)
 - (F) on a dual scale calibrated in barg or millibarg on one side and pounds per square inch on the other; and
 - (G) in accordance with the INTERNATIONAL LNG TERMINAL STANDARDS.

OPERATOR shall give CAPACITY USER as much advance notice as is reasonably practicable in the circumstances of any calibration and/or verification of any instruments or gauges referred to in this paragraph 1.3 relating to the RECEIVING FACILITY equipment, and if the LNG VESSEL's equipment is recalibrated,

CAPACITY USER must notify OPERATOR. CAPACITY USER shall be entitled to attend such calibration and/or verification but the absence of CAPACITY USER shall not affect the validity of such calibration and/or verification.

1.4 **Metering Philosophy**

OPERATOR will measure:

- (a) the quality specification of LNG unloaded and reloaded at the RECEIVING FACILITY; and
- (b) the volume and quality specification of SEND OUT GAS sent out from the RECEIVING FACILITY,

in accordance with OPERATOR's metering philosophy.

SCHEDULE 3 LNG SPECIFICATION

Component	Lean case (Mole %)	Rich case (Mole %)
Nitrogen	1.895	1.000
Carbon Dioxide	0.005	0.005
Methane	98.10	84.000
Ethane	0.00	8.395
Propane	0.00	4.000
i-Butane	0.00	1.250
n-Butane	0.00	1.250
i-Pentane	0.00	0.050
n-Pentane	0.00	0.050
Total	100	100
Molecular Weight	16.27	19.57
GHV - Btu/scf MJ/Sm ³	990 36.9	1,184 44.1
Bubble Point at -5 mbarg (⁰ C)	-166.8	-164.0
Liquid Density (kg/m ³)	439	498
Contaminant; Hydrogen Sulfide , mg/Nm ³ Total Sulphur, mg/Nm ³		Max 5.7 Max 30

Note 1. MJ/SM³ measured at 15°C and 1.01325 bara

SCHEDULE 4 SEND OUT GAS SPECIFICATIONS

PROPERTY		VALUE	UNIT
Gross Calorific Value (real gross dry)	Max	48.1	MJ/m ³
	Min	35.1	
Wobbe Index	Max	55.5	MJ/m ³
	Min	40.5	
Water dew point (at 56 barg)	Max	10	°C
Hydrocarbon dew-point (at 56 barg)	Max	10	°C
Composition			
Hydrogen sulphide	Max	5.7	mg/m ³
Total Sulphur	Max	30	mg/m ³
Oxygen	Max	0.1	Vol %
Inert Gases	Max	10	Vol %
Specific Gravity	Max	0.75	
<p>All m³ in the above table are at standard conditions of 15°C and 1.01325 bar(a).</p> <p>No impurities – free from objectionable substances i.e. dust, gums, gum-forming constituents, crude oil and other impurities that may cause pipeline damage, regulators, meters or other appliances, or that can adversely affect or interfere with (i) the transmission of the residue gas through pipeline or (ii) the commercial use of the residual gas by the CAPACITY USER. Pressure and temperature shall meet the requirements of the PGU system.</p>			

SCHEDULE 5 LNG TERMINAL FACILITY INFORMATION

INTRODUCTION

The PROJECT is designed as an LNG receiving, storage, handling and regasification facility with nameplate capacity of 3.5MTPA NATURAL GAS send-out and maximum PEAK SHAVING capacity of 7 MTPA NATURAL GAS. It will be designed to receive LNGC with capacity in the range of 130,000 m³ to 270,000 m³ for unloading operations and 5,000 m³ to 270,000 m³ for reloading operations.

RGT-2 Terminal provides facilities for unloading, reloading, storing and regasification of LNG and handling of the associated BOG. LNG from LNG carrier (LNGC) is stored in the LNG STORAGE TANKS before undergoing the regasification process. The product will then be regasified and injected through a pipeline into the PGU NETWORK and delivered to customers. The Natural Gas (NG) is measured at the Send-Out Gas Metering Station prior delivery into the NG Pipeline. Please refer to the 'Terminal Flow Diagram' attached to this Schedule V.

A. LNG JETTY TOPSIDE

LNG Jetty Topside consists of reloading and unloading facility which includes:

- (a) Unloading mooring equipment:
 - (i) four (4) breasting dolphins with fenders and low friction faced panels, two (2) of which are equipped with double quick release hooks to accommodate vessel spring lines;
 - (ii) four (4) mooring dolphins with triple quick release hooks to accommodate up to twelve (12) breast (and head/stern) lines;
 - (iii) one (1) approach velocity meter system with signalling; and
 - (iv) one (1) mooring loads monitoring system;
- (b) sufficient lighting to permit safe docking manoeuvres during day and night (to the extent permitted by the port authorities);
- (c) four (4) unloading/reloading arms which consists of two (2) liquid unloading/reloading, one (1) hybrid and one (1) vapour return, each equipped with powered emerging release couplers, and a position indication system that triggers an alarm on over-reach;
- (d) piping systems to transfer LNG into LNG tanks and vapour return to LNG VESSEL are designed for maximum unloading rates of 14,000 MMBTU/hr and maximum reloading rate of 5,000 MMBTU/hr;
- (e) fire and gas detection system inclusive of flammable gas, cold spill and fire detection combined with emergency shutdown facilities and a fixed installed fire water spray/deluge system;
- (f) radio, glass fibre-optic cable and electric cable communication links between Regasification Facilities (RF) and LNG VESSEL;
- (g) telescopic gangway with self-levelling steps to provide safe access between RF and LNG VESSEL; and

(h) security facilities and personnel in accordance with the International Ship and Port Facility Security (ISPS) Code and related port authorities requirements.

OPERATOR shall maintain a deep pocket alongside the berth with a water depth of at least 12.6 metres below the lowest astronomical tide (LAT) under LNG VESSEL's laden condition.

The RECEIVING FACILITY is designed to accept one (1) LNG VESSEL at a time with size between 5,000 m³ and 270,000 m³.

Under normal operation it will take approximate 36 to 48 hours to complete unloading depending on the size of CARGO subject to maximum unloading rate of [14,000] MMBTU/hr.

B. LNG JETTY SUBSTRUCTURE

The LNG JETTY SUBSTRUCTURE consists of the piles to support LNG JETTY TOPSIDE FACILITY and all other related equipment and facilities for LNG VESSEL berthing such as berthing dolphins, breasting dolphins, mooring hooks, fenders and LNG berthing aids.

C. LNG TANKS

The main function of the two LNG tanks is to receive and store LNG from LNG VESSEL and sending out LNG to RF for regasification.

The capacity of each LNG Tank is 200,000 m³, providing a net LNG storage capacity of 400, 000 m³.

In normal operation, each LNG tank will separately receive LNG from LNG VESSEL and pump out LNG from LNG tank to RF. However, each LNG tank is capable to simultaneously receive LNG from LNG VESSEL and pump out LNG from such LNG tank to RF.

For unloading operation, LNG VESSEL will maintain tank pressure of 100 milibarg to 150 milibarg upon berthing and LNG Tank will require higher pressure in order to send part of the BOIL OFF GAS back to the LNG VESSEL as vapour return. BOG COMPRESSOR will provide sufficient pressure to evacuate the BOIL OFF GAS generated in the LNG Tank. Both LNG Tanks' vapour manifolds are permanently connected to the JT vapour return arms for BOIL OFF GAS management except during emergency situation.

For reloading operation, LNG VESSEL to maintain tank pressure of 100 milibarg upon berthing and LNG VESSEL shall be capable of returning back part of the BOIL OFF GAS back to the LNG Tank as vapour return.

The maximum LNG pump out rate from LNG TANKs to RF is 1400 MMBTU/hr at 12.7 barg of pressure to RF.

D. LNG REGASIFICATION UNIT (RU)

LNG Regasification Unit consists of:

(a) BOG Recondenser;

(b) LNG Send Out Systems, which each consists of:

- i. Four (4) LNG High Pressure (HP) In Tank Pumps; and
 - ii. Four (4) Open Rack Vaporizers (ORV);
- (c) Three (3) Boil Off Gas Compressors and its associated facilities consisting of:
- i. BOG Compressor Desuperheater; and
 - ii. BOG Compressor Suction Drum.

A small portion of LNG is sent to BOG Compressor Desuperheater to reduce the temperature of the BOG. It is then routed to the BOG Compressor Suction Drum to drain any liquid.

Main portion of the LNG will pass through the bottom of BOG Recondenser, which will act as a liquid hold up for the HP LNG Pumps.

LNG is sent to HP LNG Pumps to bring the LNG to the same pressure as the PGU NETWORK pressure. The HP LNG Pumps are equipped with Variable Speed Drive (VSD) to enable the pumps to seamlessly adapt to the PGU NETWORK pressure.

LNG is regasified into NATURAL GAS at the Open Rack Vaporizers. NATURAL GAS is heated to a minimum temperature of 15 degrees Celsius. NATURAL GAS passes through the SEND OUT GAS METERING STATION before delivery to the PGU NETWORK as SEND OUT GAS. Design send out rate of 5 MTPA, is achieved through the operation of three sets of LNG In-Tank Pumps, HP LNG Pumps and Open Rack Vaporizers. Maximum send out rate of 7 MTPA is achieved by operating all equipment without any spares.

The BOG Compressors are used to recover BOIL OFF GAS in the BOIL OFF GAS header. It is routed into the BOG Recondenser for the gas to recondense into LNG.

The RF is also equipped with four (4) LNG Reloading Pumps working at maximum capacity of [5000] MMBTU/hr to enable send out of LNG into LNG VESSEL (Reloading).

LNG Drain Pump is used to drain the unloading/reloading line and the recirculation line.

E. SEND OUT GAS METERING STATION

The SEND OUT GAS METERING STATION consists of three (3) x 50% metering runs. The quantity and quality of the SEND OUT GAS are measured at the SEND OUT GAS METERING STATION.

The SEND OUT GAS METERING STATION is equipped with the following parts:

- (a) Three (3) ultrasonic flow meters with pressure and temperature compensation;
- (b) Two (2) gas chromatographs to determine gas composition and calorific value;
- (c) One (1) moisture analyser;
- (d) One (1) Hydrogen Sulphide (H₂S) analyser; and
- (e) One (1) hydrocarbon dew point analyser.

The SEND OUT GAS pressure varies between 38 barg and 68.95 barg, and dependent upon the PGU NETWORK pressure.

F. SUPPORTING INFRASTRUCTURES

RECEIVING FACILITY is supported with the following supporting infrastructures which includes:

- a) a flare system for the release of excess BOIL OFF GAS at abnormal situations in a controlled and environmentally responsible manner;
- b) an electrical power distribution network within the RECEIVING FACILITY;
- c) a process control system and safety control system, allowing a high level of plant automation and "fail-safe" corrections if abnormal situations (e.g. spill or fire) are detected; and
- d) a utility system to support the operations of the RECEIVING FACILITY such as Instrument Air System, Plant Air System, Fuel Gas System, Firewater System, Nitrogen System, Sea Water System, Service Water System, Waste Water Treatment System, Potable Water system and Close Drain System

Jetty Layout

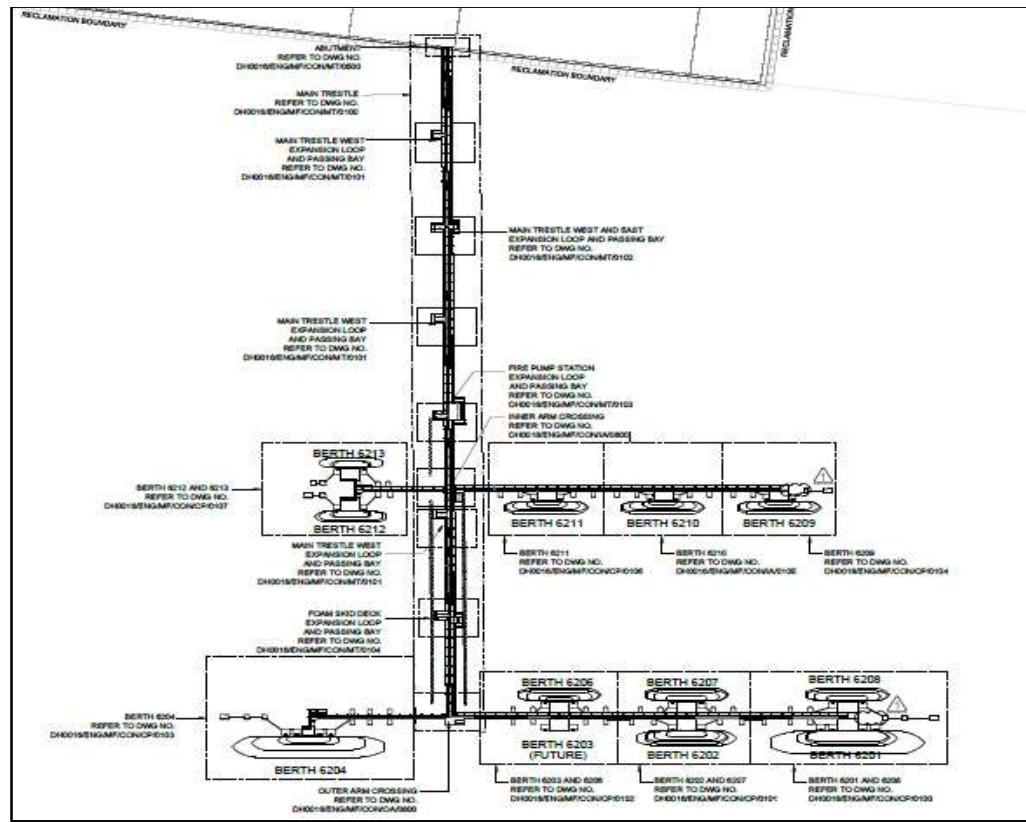

Figure 1: Overall Layout

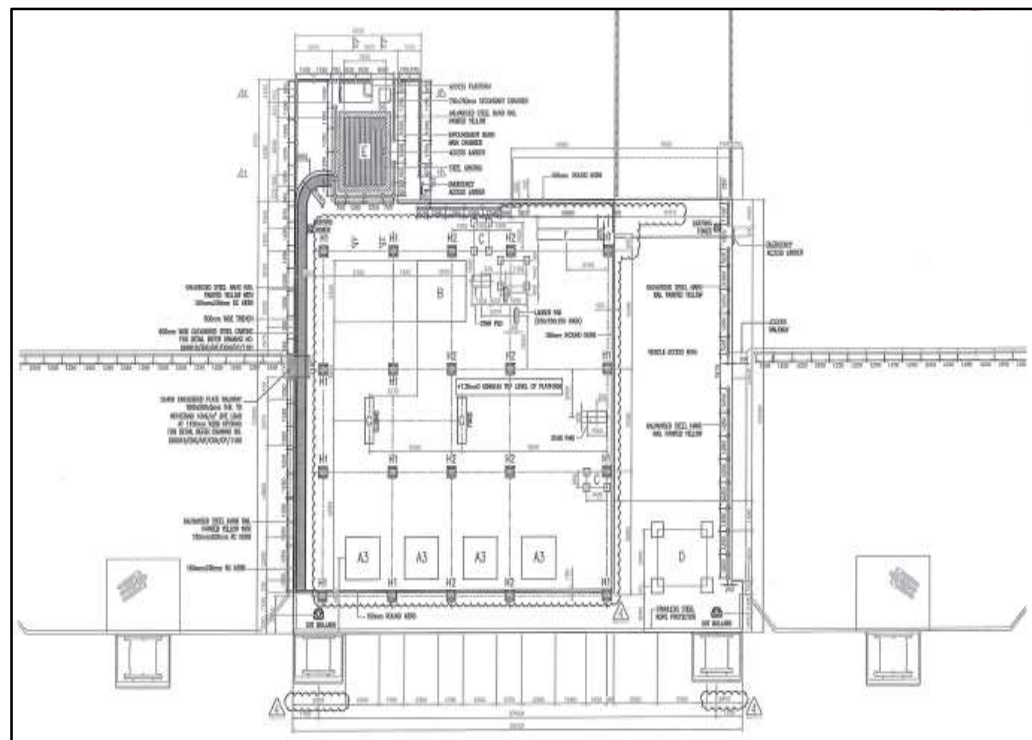
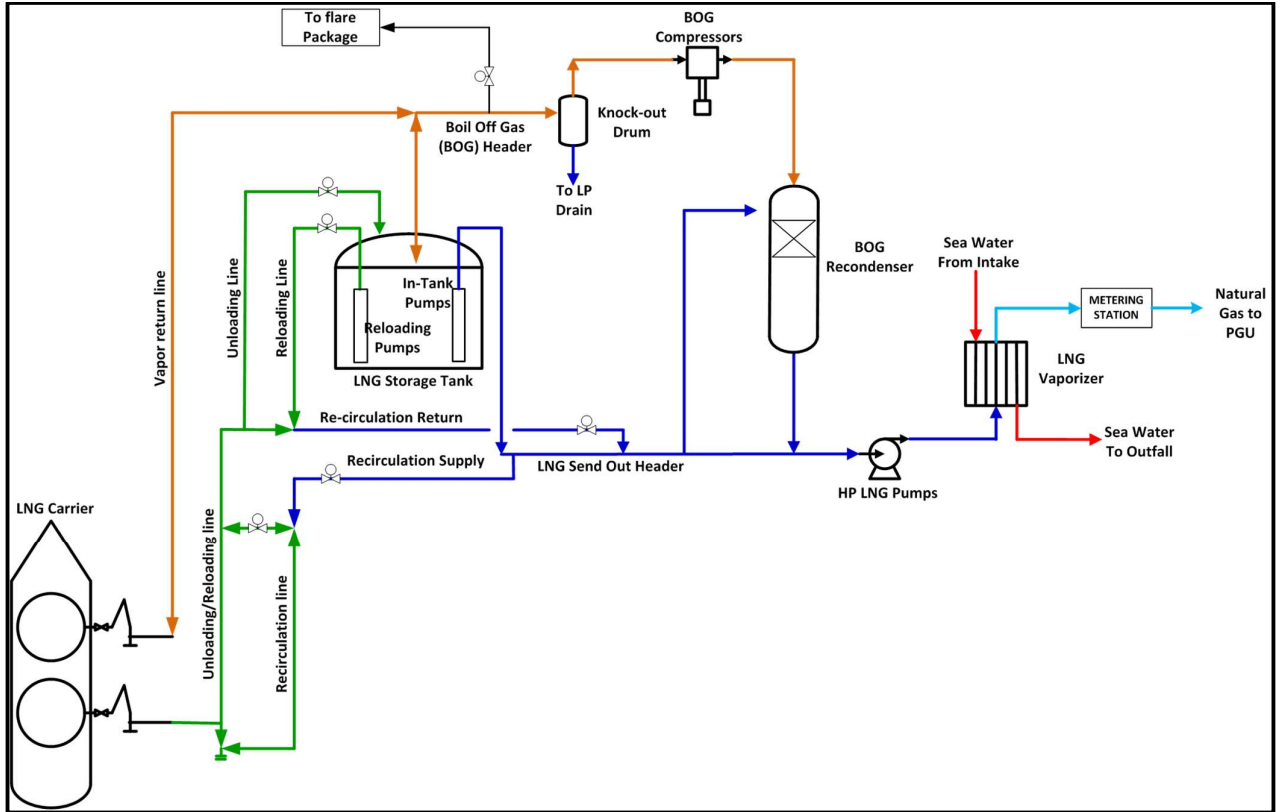

Figure 2: BERTH 6204 Central Platform Layout

TERMINAL FLOW DIAGRAM



SCHEDULE 6 ALLOCATION RULES

1. INTRODUCTION

- 1.1 Allocation is an arrangement whereby OPERATOR allocates the proper share of the quantity of SEND OUT GAS, IGC and LNG across the RECEIVING FACILITY to each CAPACITY USERS in a fair and non-discriminatory manner.
- 1.2 These allocation rules are meant to describe principle for daily allocation of SEND OUT GAS, IGC and LNG across the RECEIVING FACILITY between the CAPACITY USERS.

2. SEND OUT GAS QUANTITY ALLOCATION

- 2.1 OPERATOR shall allocate the delivered SEND OUT GAS quantity for each GAS DAY to CAPACITY USERS after closing of each actual GAS DAY.
- 2.2 CAPACITY USERS acknowledge that the receipt of SEND OUT GAS at NATURAL GAS DELIVERY POINT may not exactly match the daily nomination made in respect of it and consequently under deliveries or over deliveries of daily SEND OUT GAS may occur and as a result from but not limited to any RECEIVING FACILITY operational limitation, tank inventory limitation and PGU NETWORK limitation.
- 2.3 All of daily SEND OUT GAS quantity delivered at NATURAL GAS DELIVERY POINT as measured at SEND OUT GAS METERING STATION shall be allocated to CAPACITY USERS regardless of the reason for any such under deliveries or over deliveries.
- 2.4 The principle of the SEND OUT GAS quantity allocation is as follows:

where

A = CAPACITY USER's daily nomination quantity for each GAS DAY;

B = Total daily nomination quantity by all the CAPACITY USERS for each GAS DAY; and

C = Total actual daily SEND OUT GAS quantity for each GAS DAY.

$$\text{CAPACITY USER's daily actual SEND OUT GAS quantity, } a = \frac{A}{B} \times C$$

3. INTERNAL GAS CONSUMPTION

- 3.1 CAPACITY USERS acknowledge that the quantity of the IGC will vary between GAS DAYS due to, amongst other reasons, the variation of usage as pilot flare and as sweep gas, and flaring and venting for the purpose of operation, MAINTENANCE and safety.
- 3.2 CAPACITY USER'S share of IGC in the circumstances set out in AA 16.3 shall be calculated as follows:

Where;

D_C = CAPACITY USER'S MINIMUM SEND OUT RATE ;

D_T = Terminal's MINIMUM SEND OUT RATE

E_C = CAPACITY USER'S DAILY SEND OUT GAS NOMINATION ;

E_T = Total DAILY SEND OUT GAS NOMINATION; and

F = Total actual daily IGC quantity for each GAS DAY.

$$\text{CAPACITY USER'S actual daily IGC quantity, } d = \frac{D_C - E_C}{D_T - E_T} \times F$$

4. LNG QUANTITY IN TANKS ALLOCATION

- 4.1 OPERATOR shall allocate each CAPACITY USER'S LNG daily closing quantity in the tanks after closing of each actual GAS DAY based on the following mechanism.
- 4.2 The LNG quantity remains in tanks in any GAS DAY shall be allocated to each CAPACITY USER after taking into consideration actual quantity allocation of the SEND OUT GAS and IGC in each GAS DAY for each CAPACITY USER as specified in paragraph 2 and 3 above.
- 4.3 The principle of the LNG inventory allocation as follows:

Where;

G = CAPACITY USER'S opening LNG inventory in tank for each GAS DAY;

J = Assignment of LNG from other CAPACITY USER;

H = Assignment of LNG to other CAPACITY USER;

a = CAPACITY USER'S daily actual SEND OUT GAS quantity for each GAS DAY; and

d = CAPACITY USER'S daily actual IGC quantity for each GAS DAY.

$$\text{CAPACITY USER'S LNG daily closing quantity in tanks, } g = G - a - d + J - H$$

SCHEDULE 7 PDWT PORT LIMIT

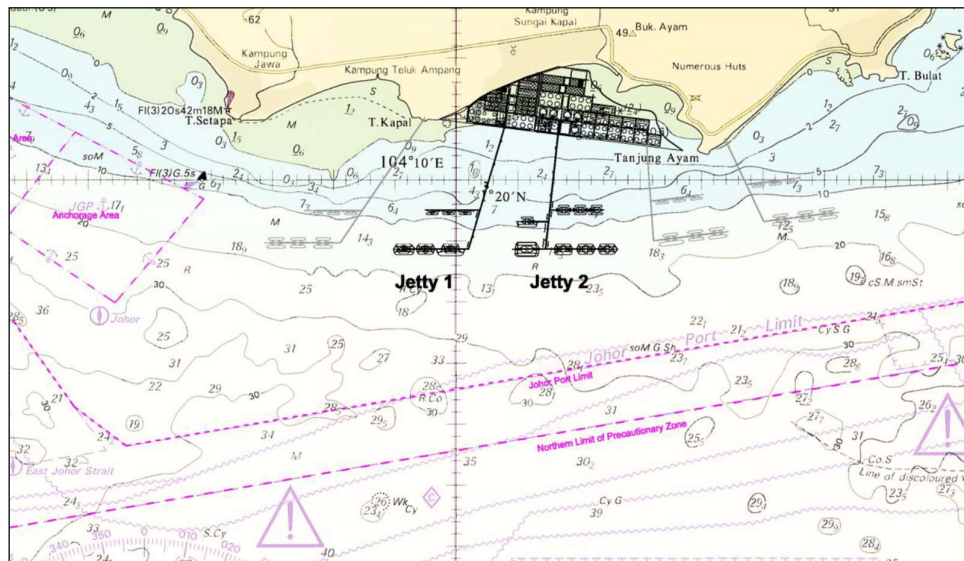

Figure 3: Charted location of PDWT

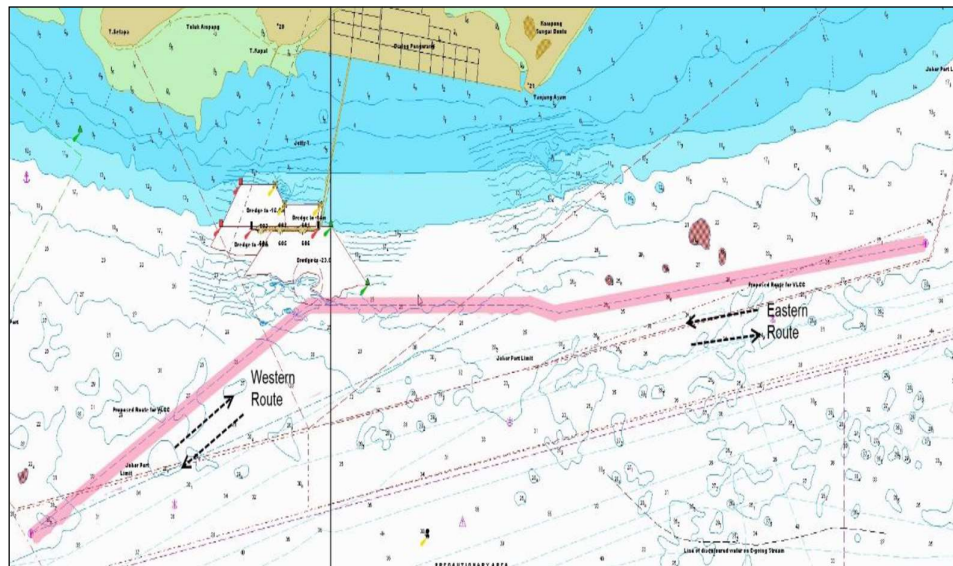

Figure 4: Deep water routes

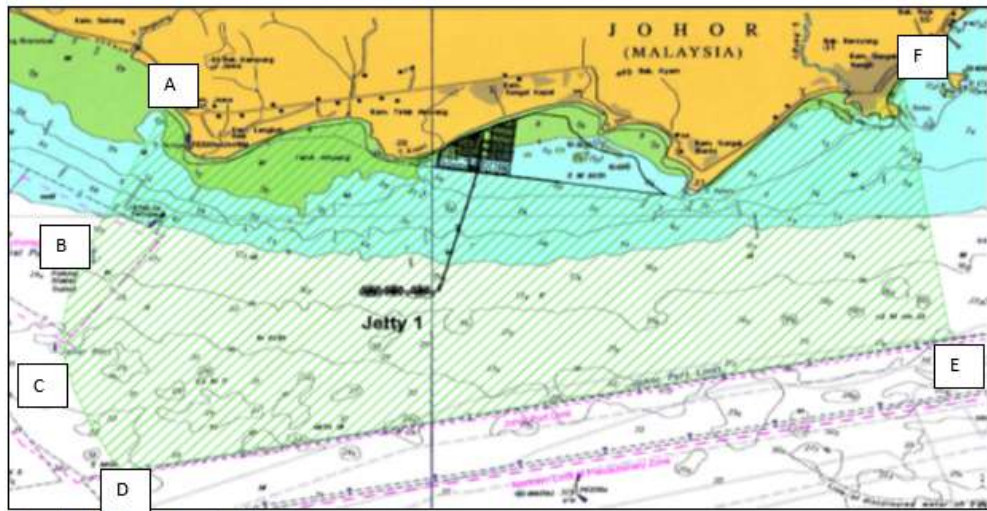
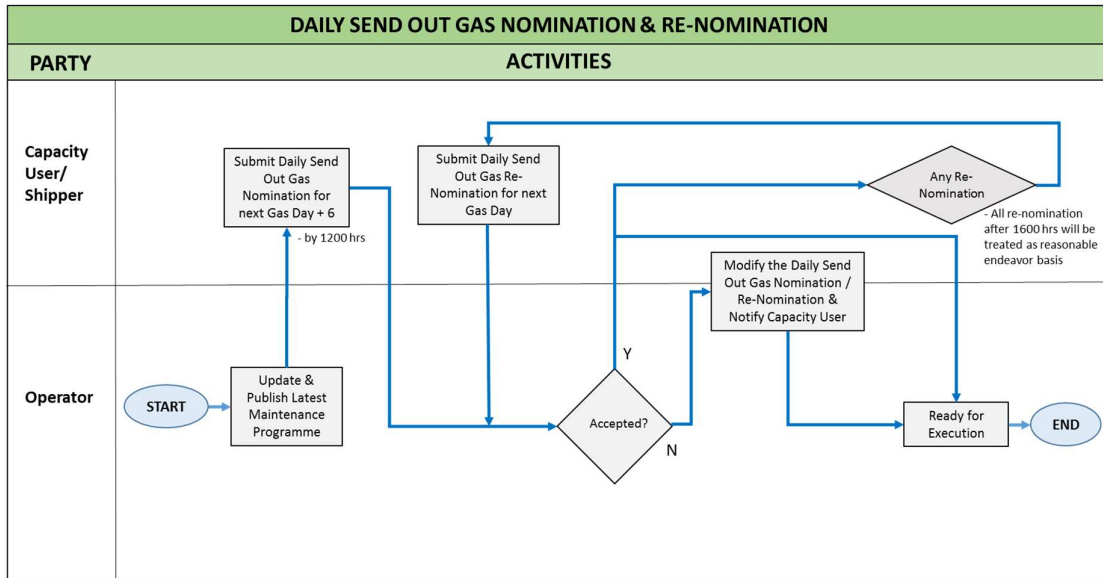

Figure 5: Exclusive Operation Area (EOA)

POINT	LATITUDE	LONGITUDE
A	01°20' 34.8" N	104°08' 07.4"E
B	01°19'06.5"N	104°07'23.1"E
C	01°18'42.7"N	104°07'22.5"E
D	01°17'50.4"N	104°07'19.4"E
E	01°19'01.3"N	104°14'01.3"E
F	01°21'27.3"N	104°13'53.2"E

The EOA Covers the above Designated Coordinates

SCHEDULE 8 DAILY SEND OUT GAS NOMINATION PROCEDURE



SCHEDULE 9 FORM OF ACCESS REQUEST

[**Note:** See separate document.]

SCHEDULE 10 CAPACITY USER CREDIT REQUIREMENTS

1.0 ADDITIONAL DEFINITIONS:

ACCEPTABLE CREDIT RATING means in relation to a CAPACITY USER:

- (a) a rating for its long term unsecured and non-credit enhanced debt obligations of [A-] or higher by Standard & Poor's Rating Services or Fitch Ratings Ltd or [A3] or higher by Moody's Investor Services Limited; or
- (b) a comparable rating from an internationally recognised credit rating agency but, where the ratings issued by rating agencies for such obligations of a particular entity differ, applying the lowest of such ratings; or
- (c) any other rating approved by OPERATOR;

GUARANTEE means an irrevocable on-demand bank guarantee issued by an internationally recognised bank that is acceptable to OPERATOR containing terms substantially similar to the form included in Appendix 1 to this Schedule 10 or as otherwise acceptable to OPERATOR.

2.0 CREDIT REQUIREMENTS

2.1 Each CAPACITY USER shall:

- (a) supply to OPERATOR one (1) original or certified true copy of the CAPACITY USER'S audited accounts:
 - (i) for the three (3) years immediately preceding the EFFECTIVE DATE at OPERATOR'S request; and
 - (ii) the most recent audited accounts as at the EFFECTIVE DATE, and as at each financial year end thereafter,

as soon as they are available (and in any event no later than the date which is [six (6) months] after the end of the CAPACITY USER'S financial year), together with a statement containing an estimate of the CAPACITY USER'S total assets less total liabilities as derived from the CAPACITY USER'S latest audited accounts, based on these accounts;

- (b) ensure that any reports or accounts provided pursuant to paragraph 2.1(a) give a true and fair view of the CAPACITY USER'S financial position as at the date at which those reports or accounts were drawn up; and
- (c) supply to OPERATOR any other information reasonably requested to enable OPERATOR to make a determination under paragraph 2.2.

2.2 Upon receipt by OPERATOR of the information set out in paragraph 2.1 above, OPERATOR shall determine in its discretion whether it shall require a GUARANTEE and, if a GUARANTEE is required, the amount of such GUARANTEE, provided that OPERATOR shall not require GUARANTEE if CAPACITY USER has an ACCEPTABLE CREDIT RATING.

- 2.3 Following a determination by OPERATOR pursuant to paragraph 2.2 above that GUARANTEE is required with respect to a CAPACITY USER, OPERATOR shall notify the relevant CAPACITY USER of such determination and which form or forms of GUARANTEE is required by OPERATOR from that CAPACITY USER. Promptly and in any event within 14 days following such notification by OPERATOR CAPACITY USER shall procure and maintain (for so long as OPERATOR requires) the required GUARANTEE.
- 2.4 CAPACITY USER should replace any GUARANTEE no later than 30 days before such GUARANTEE expires with replacement GUARANTEE in substantially the same form.
- 2.5 If an entity providing GUARANTEE ceases to be acceptable to OPERATOR, CAPACITY USER shall within 14 days provide an alternative GUARANTEE in substantially the same form from a replacement entity that is acceptable to OPERATOR.
- 2.6 If CAPACITY USER fails to comply with the requirements of paragraphs 2.3, 2.4 or 2.5 above and such failure is not cured within five (5) days after receipt of notice from OPERATOR of such failure, OPERATOR may, without any liability on the part of OPERATOR, suspend or discontinue the provision of SERVICES to the relevant CAPACITY USER for the duration of such failure and/or may terminate the TERMINAL USE AGREEMENT in accordance with AA 20.2(d).

APPENDIX 1

FORM OF GUARANTEE

BANK GUARANTEE NO.:

PENGERANG LNG (TWO) SDN BHD
Tower 1, PETRONAS Twin Towers,
Kuala Lumpur City Centre,
50088 Kuala Lumpur.

AN AGREEMENT made the _____ day of _____ 201[●] between
_____ (hereinafter referred to as the "Bank") of the one part and
PENGERANG LNG (TWO) SDN BHD (hereinafter called the "Seller") of the other part.

WHEREBY IT IS AGREED as follows:

1. In consideration of Seller agreeing to render **regasification** services to _____ (hereinafter referred to as the "Buyer"), the Bank hereby irrevocably and unconditionally guarantees and undertakes the payment to the Seller, as principal debtor and not merely as surety, on first demand, free of offsets or counterclaims, without restriction or conditions and notwithstanding any contestation or objection by with Buyer, such sums of money not exceeding **Ringgit Malaysia/United States Dollar** _____ (**RM/USD** _____) which may at any time be claimed by the Seller against the Buyer for the Buyer's failure to settle any amounts due under **Terminal Use Agreement (TUA)** between the Seller and the Buyer dated _____ and any amendments thereto which may subsequently be agreed upon by the Seller and the Buyer.
2. Notice in writing, without proof or conditions, of any claims by the Seller against the Buyer shall be given to the Bank, and within 7 days from the date of receipt of such notice full payment shall forthwith be made by the Bank to the Seller of all sums due under this guarantee.
3. This guarantee shall be effective for the period of _____ from the date hereof and shall expire on _____ and renewed at least 30 days before the expiry of the guarantee in the form similar and in the amount to be based on the provisions of the **TUA**.
4. The liability of the Bank shall not be affected nor shall this guarantee be discharged or diminished by reason of:
 - 4.1. any amendment, modification, extension, indulgence, waiver, or concession granted to the Buyer by the Seller, whether as to payment, time, performance or otherwise;
 - 4.2. any renewal, variation, compromise or composition relating to the **TUA** or refusal or neglect to perfect the **TUA** or any decision by the Seller to not enforce the **TUA** or sue the Buyer;

- 4.3. any change whatsoever in the constitution of the Buyer or by the Buyer's liquidation or winding up or any legal limitation, disability, incapacity or similar circumstances relating to the Buyer; or
- 4.4. any act or omission on the part of the Seller which but for this provision might operate to exonerate or discharge the Bank from any of its obligations under this guarantee.
5. This guarantee shall ensure to the benefit of the Seller and its successors and assigns pursuant to the **TUA** notwithstanding any amalgamation, merger, reconstruction under this guarantee.
6. This guarantee shall remain in full force and effect notwithstanding any amalgamation, merger, reconstruction or any other change in the constitution of the Bank.
7. This guarantee is a continuing guarantee within the limits aforesaid as to time and amount. However any claim by the Seller for the Buyer's failure to settle any amount due under the **TUA** shall be submitted to the Bank within 1 month(s) after the expiry of the said time.
8. This guarantee shall be governed by and construed exclusively in accordance with the laws of Malaysia.
9. The Bank hereby waives notice of acceptance and execution of this Bank Guarantee by the Seller.

IN WITNESS WHEREOF the Bank hereto have hereunto set their hands the day and year first above written.

Signed for and on behalf of the Bank)
)
).....
 Name)
 Designation)
)

In the presence of:)
).....
 Name)
 Designation)

END OF SCHEDULE

SCHEDULE 11

FORM OF NOVATION AGREEMENT FOR ENTIRE SERVICE TRANSFER

THIS NOVATION AGREEMENT is made on [●]

BETWEEN:

- (1) [●] (No. ●) whose registered office is at [●] (the "ORIGINAL PARTY")
 - (2) Pengerang LNG (TWO) Sdn Berhad (Company No. 985991-U), a company incorporated in Malaysia under the Companies Act, 1965 and having its registered address at Level 51, Tower 1, PETRONAS Twin Towers, Kuala Lumpur City Centre, 50088 Kuala Lumpur, Malaysia (hereinafter referred to as the "OPERATOR"); and
 - (3) [●] (No. ●) whose registered office is at [●] (the "NEW PARTY")
- (each a "PARTY" and together the "PARTIES").

RECITALS

- I. The ORIGINAL PARTY and OPERATOR are parties to a TERMINAL USE AGREEMENT dated [●] pursuant to which the ORIGINAL PARTY was provided with SERVICES (as defined in the TERMINAL USE AGREEMENT).
- II. OPERATOR carries on the ownership and operation of the LNG regasification facilities to be located within the Pengerang Deep Water Terminal in Pengerang, Johor, Malaysia.
- III. The ORIGINAL PARTY wishes to be released from all its obligations and liabilities under the TERMINAL USE AGREEMENT and to transfer all its rights under the TERMINAL USE AGREEMENT to the NEW PARTY. The NEW PARTY wishes to assume all such rights, obligations and liabilities of the ORIGINAL PARTY under the TERMINAL USE AGREEMENT in substitution for the ORIGINAL PARTY. OPERATOR intends to agree to such release and substitution.
- IV. The ORIGINAL PARTY and the NEW PARTY delivered to OPERATOR notice of their intention to effect an ENTIRE SERVICE TRANSFER (as defined in the TERMINAL USE AGREEMENT) in accordance with AA 26.3(a) of the TERMINAL USE AGREEMENT on [*insert date*].
- V. OPERATOR provided written confirmation of its consent to the ENTIRE SERVICE TRANSFER in accordance with AA 26.3(b) of the TERMINAL USE AGREEMENT on [*insert date*].
- VI. Pursuant to and in accordance with the terms of AA 26.4 of the TERMINAL USE AGREEMENT, the PARTIES have agreed to the ENTIRE SERVICE TRANSFER on the terms and subject to the conditions of this NOVATION AGREEMENT.

THE PARTIES AGREE AS FOLLOWS:

2.0 DEFINITIONS

Capitalised terms used in this NOVATION AGREEMENT shall have the same meaning ascribed to them in the TERMINAL USE AGREEMENT.

3.0 CONDITIONS

- 3.1 This NOVATION AGREEMENT will become effective on [the later of [●] and the date on which the conditions precedent set out in Appendix 1 to this NOVATION AGREEMENT (the "CONDITIONS PRECEDENT") have been satisfied or waived in accordance with clause 3.2] (such time being the ENTIRE SERVICE TRANSFER EFFECTIVE TIME in accordance with AA 26.4 of the TERMINAL USE AGREEMENT).
- 3.2 OPERATOR may waive any of the CONDITIONS PRECEDENT by giving notice to the ORIGINAL PARTY and the NEW PARTY.
- 3.3 The ORIGINAL PARTY and the NEW PARTY shall keep OPERATOR informed on a regular basis regarding its progress in satisfying the CONDITIONS PRECEDENT and shall notify OPERATOR promptly upon the CONDITIONS PRECEDENT being satisfied.
- 3.4 CAPACITY USER shall use REASONABLE ENDEAVOURS to procure that the CONDITIONS PRECEDENT are satisfied within [one (1)] month of the date of this NOVATION AGREEMENT, or such later date as may be agreed under clause 3.5.
- 3.5 If a CONDITION PRECEDENT has not been waived or satisfied by the date falling [one (1)] month after the date of this NOVATION AGREEMENT, the PARTIES will meet and seek to agree upon a later date by which the CONDITION PRECEDENT will, if possible, be satisfied. If the PARTIES fail to reach agreement upon a later date (which shall in no event be later than the date falling [three (3)] months] after the date of this NOVATION AGREEMENT), any PARTY may terminate this NOVATION AGREEMENT without liability on its part by giving notice to the other PARTIES. Termination shall be a PARTY'S sole remedy for the failure to satisfy a CONDITION PRECEDENT not waived. The same rights of waiver or termination, and the procedures relating thereto, will apply upon the expiry of any later period agreed by the PARTIES pursuant to this clause 3.

4.0 TERMINAL USE AGREEMENT

Each of the ORIGINAL PARTY and OPERATOR hereby severally confirms to the NEW PARTY that except as disclosed to the NEW PARTY:

- (a) the TERMINAL USE AGREEMENT is in full force and effect between the ORIGINAL PARTY and OPERATOR and that, except as disclosed to the NEW PARTY, neither has assigned or otherwise transferred any of their respective rights or obligations under or in connection with the TERMINAL USE AGREEMENT; and
- (b) except as disclosed to the NEW PARTY, the copy of the TERMINAL USE AGREEMENT annexed hereto (and initialled for the purpose of identification by

the parties hereto) is a true and complete copy thereof [and that there has been no amendment thereto since its execution].

5.0 NOVATION

5.1 With effect from the ENTIRE SERVICE TRANSFER EFFECTIVE TIME:

- (a) Without prejudice to (i) any rights accrued by OPERATOR; or (ii) any liabilities incurred by the ORIGINAL PARTY, in either case under or in connection with the TERMINAL USE AGREEMENT prior to the ENTIRE SERVICE TRANSFER EFFECTIVE TIME, OPERATOR releases and discharges the ORIGINAL PARTY from all its obligations and liabilities and from all claims and demands of whatever nature arising under or in connection with the TERMINAL USE AGREEMENT insofar as they arise or relate to events occurring on or after the ENTIRE SERVICE TRANSFER EFFECTIVE TIME.
- (b) The NEW PARTY agrees with OPERATOR to perform all the obligations and assume all the liabilities of the ORIGINAL PARTY from which the ORIGINAL PARTY is released and discharged pursuant to clause 5.1 (a) of this NOVATION AGREEMENT and to be bound by the terms of the TERMINAL USE AGREEMENT in all respects as if the NEW PARTY had been named as a party to the TERMINAL USE AGREEMENT in place of the ORIGINAL PARTY (but which, for the avoidance of doubt, shall not include any obligations or liabilities arising from any act or omission of the ORIGINAL PARTY which occurred prior to the ENTIRE SERVICE TRANSFER EFFECTIVE TIME).
- (c) OPERATOR agrees with the NEW PARTY to perform all OPERATOR'S obligations and assume all its liabilities under or in connection with the TERMINAL USE AGREEMENT and to be bound by the terms of the TERMINAL USE AGREEMENT in all respects as if the NEW PARTY had been named as a party to the TERMINAL USE AGREEMENT in place of the ORIGINAL PARTY (but which, for the avoidance of doubt, shall not include any obligations or liabilities arising from any act or omission of OPERATOR which occurred prior to the ENTIRE SERVICE TRANSFER EFFECTIVE TIME).
- (d) Each of the ORIGINAL PARTY and OPERATOR acknowledge and agree that, on and with effect from the ENTIRE SERVICE TRANSFER EFFECTIVE TIME, neither shall have any claims against the other in relation to any act or omission of the other under or in connection with the TERMINAL USE AGREEMENT which may occur on or after the ENTIRE SERVICE TRANSFER EFFECTIVE TIME.

6.0 MUTUAL INDEMNITIES

6.1 The NEW PARTY indemnifies the ORIGINAL PARTY and shall keep the ORIGINAL PARTY indemnified against all liability, costs, damages or claims incurred by or made against the ORIGINAL PARTY by OPERATOR relating to any act or omission occurring under or in connection with the TERMINAL USE AGREEMENT on or after the ENTIRE SERVICE TRANSFER EFFECTIVE TIME.

6.2 The ORIGINAL PARTY indemnifies the NEW PARTY and shall keep the NEW PARTY indemnified against all liability, costs, damages or claims incurred by or made against the NEW PARTY by OPERATOR relating to any act or omission occurring under or in connection with the TERMINAL USE AGREEMENT prior to the ENTIRE SERVICE TRANSFER EFFECTIVE TIME.

7.0 AFFIRMATION

Except as specifically amended by this NOVATION AGREEMENT all the terms and conditions of the TERMINAL USE AGREEMENT remain in full force and effect.

8.0 GOVERNING LAW

This NOVATION AGREEMENT and any dispute, controversy, proceedings or claim of whatever nature arising out of or in any way relating to this NOVATION AGREEMENT or its formation (including any non-contractual disputes or claims) shall be governed by and construed in accordance with Malaysian law.

IN WITNESS whereof this agreement has been executed on the date first above written.

Signed for an on behalf of)
[ORIGINAL PARTY])
)
)
Signature of director
Signature of witness
Name of witness
Address of witness
.....
.....
Occupation of witness

Signed for an on behalf of)
PENGERANG LNG (TWO) SDN)
BERHAD)
)

Signature of director

Signature of witness

Name of witness

Address of witness

.....

.....

Occupation of witness

Signed for an on behalf of)
[NEW PARTY])
)
)

Signature of director

Signature of witness

Name of witness

Address of witness

.....

.....

Occupation of witness

APPENDIX 1

CONDITIONS PRECEDENT TO ENTIRE SERVICE TRANSFER

1.0 NOTICE TO TRANSFER

- 1.1 Delivery by the ORIGINAL PARTY and the NEW PARTY to OPERATOR a notice of their intention to effect such an ENTIRE SERVICE TRANSFER in accordance with AA 26.3(a) of the TERMINAL USE AGREEMENT at least [●] days before the proposed ENTIRE SERVICE TRANSFER EFFECTIVE TIME.
- 1.2 Receipt by the ORIGINAL PARTY and the NEW PARTY of OPERATOR'S written confirmation that it consents to the proposed ENTIRE SERVICE TRANSFER in accordance with AA 26.3(b) of the TERMINAL USE AGREEMENT.

2.0 ACCESS REQUIREMENT

- 2.1 The NEW PARTY is licenced under section 11 of the GAS SUPPLY ACT to import gas to a regasification terminal in Malaysia.
- 2.2 The NEW PARTY meets the credit requirements set out in Schedule 10 of Appendix 1 of the TERMINAL USE AGREEMENT.
- 2.3 The NEW PARTY has entered into an LNG sale and purchase agreement with an LNG supplier for the supply of LNG to the RECEIVING FACILITY.
- 2.4 The NEW PARTY has entered into a TERMINAL USE AGREEMENT with PETRONAS Gas Berhad for the transportation of gas through the PGU NETWORK.
- 2.5 The NEW PARTY has entered into a gas sales agreement for the sale of regasified LNG processed at the RECEIVING FACILITY.

3.0 ACCESSION TO THE INTER-CAPACITY USERS AGREEMENT

- 3.1 Execution of an accession agreement to the INTER-CAPACITY USER AGREEMENT (in the form set out in Schedule 1 to that agreement) by the NEW PARTY, OPERATOR, the PETRONAS (as defined in the INTER-CAPACITY USER AGREEMENT) and the OTHER CAPACITY USERS (as defined in the INTER-CAPACITY USER AGREEMENT).

SCHEDULE 12 FORM OF INTER-CAPACITY USER AGREEMENT

[**Note:** See separate document.]

SCHEDULE 13 FORM OF PARTIAL SERVICE TRANSFER APPROVAL

[on letterhead of OPERATOR]

[date]

[CAPACITY USER]

[PROPOSED TRANSFEREE]

Dear Sirs,

We refer to:

- (a) the TERMINAL USE AGREEMENT dated [●] between [CAPACITY USER] and ourselves (the "TERMINAL USE AGREEMENT");
- (b) the TERMINAL USE AGREEMENT dated [●] between [PROPOSED TRANSFEREE] and ourselves (the "TRANSFEREE TERMINAL USE AGREEMENT"); and
- (c) your joint written notice of your intention to effect a PARTIAL SERVICE TRANSFER pursuant to AA 26.6(a) of the TERMINAL USE AGREEMENT submitted to us on [●].

[summarise details of PARTIAL SERVICE TRANSFER. This should reflect the SERVICE ENTITLEMENT being transferred.]

The [PROPOSED TRANSFEREE] undertakes to the [OPERATOR and the CAPACITY USERS] to perform the obligations and assume the liabilities of [CAPACITY USER] the subject of the PARTIAL SERVICE TRANSFER under the terms of [PROPOSED TRANSFEREE'S] TERMINAL USE AGREEMENT and to be bound by the terms of [PROPOSED TRANSFEREE'S] TERMINAL USE AGREEMENT in respect of all matters relating to the PARTIAL SERVICE TRANSFER from the PARTIAL SERVICE TRANSFER EFFECTIVE TIME until the PARTIAL SERVICE TRANSFER TERMINATION TIME.

The [CAPACITY USER] acknowledges and agrees that for the duration of the PARTIAL SERVICE TRANSFER its [insert relevant SERVICE ENTITLEMENT] shall be reduced to [insert relevant information]. The [CAPACITY USER's] remaining [insert relevant SERVICE ENTITLEMENT] for the duration of the PARTIAL SERVICE TRANSFER under its TERMINAL USE AGREEMENT shall be [insert the non-transferring SERVICE ENTITLEMENT that remains with the original CAPACITY USER].

The PARTIAL SERVICE TRANSFER EFFECTIVE TIME for the above PARTIAL SERVICE TRANSFER shall be [●].

The PARTIAL SERVICE TRANSFER TERMINATION TIME shall be *[insert]*.

On and from the PARTIAL SERVICE TRANSFER TERMINATION TIME:

- (a) all rights and obligations in respect of the PARTIAL SERVICE TRANSFER shall revert back to the [CAPACITY USER] to be performed in accordance with the terms of its TERMINAL USE AGREEMENT;

(b) the [CAPACITY USER's] [insert relevant SERVICE ENTITLEMENT] shall be increased back to [insert original SERVICE ENTITLEMENT]; and

(c) the [PROPOSED TRANSFEREE'S] [insert relevant SERVICE ENTITLEMENT] under its TERMINAL USE AGREEMENT shall be reduced back to [insert previous SERVICE ENTITLEMENT].

We consent to the PARTIAL SERVICE TRANSFER referred to above.

Please acknowledge your agreement to the PARTIAL SERVICE TRANSFER by countersigning the enclosed copy of this letter and returning this to us no later than [●].

Yours faithfully,

For and on behalf of
PENGERANG LNG (TWO) SDN. BHD.

Acknowledged and agreed:

For and on behalf of
[CAPACITY USER]
[date]

For and on behalf of
PROPOSED TRANSFEREE
[date]

SCHEDULE 14 CALORIFIC AND VOLUMETRIC CONVERSION FORMULA

1. Mass to volume:

$$\text{Mass (kg)} \div \text{Density (kg/m}^3\text{)} = \text{Volume (m}^3\text{)}$$

2. Volume to Energy:

$$\text{Volume (mmscf)} \times \text{GHV (mmbtu/mmscf)} = \text{Energy (mmbtu)}$$

3. GHV, density and specific energy used for planning purpose*

GHV : 1050 mmbtu/mmscf

LNG density : 450 kg/m³

LNG specific energy : 25,300 MJ/m³, equivalent to 56.3 MJ/kg

*The numbers are the medians for multiple LNG sources worldwide, as can be found from the Natural Gas Conversion Guide, International Gas Union, 2012.